



Ordering information

Type	Part no.
DML40-2-1211	1027608

Other models and accessories → www.sick.com/DML



Detailed technical data

Mechanics/electronics

Supply voltage V_S	DC 18 V ... 30 V, limit values
Ripple	5 V _{pp} ¹⁾
Power consumption	≤ 6 W ²⁾
Initialization time	6 s
Connection type	1 x terminal connection, 1 x Sub D, 9-pin
Weight	Approx. 1,200 g
Dimensions (W x H x D)	61 mm x 85 mm x 166 mm
Enclosure rating	IP65
Protection class	III ³⁾

¹⁾ May not fall short of or exceed V_S tolerances.

²⁾ Without load.

³⁾ Reference voltage DC 50 V PELV-voltage (EN 50178).

Performance

Measuring range	0.5 m ... 600 m, on reflective tape "Diamond Grade" ¹⁾ 0.5 m ... 800 m, on reflector PL880FS01 ²⁾ 0.5 m ... 1,200 m, on reflector OP60 ³⁾
Target	Reflector
Resolution	≤ 1 mm
Repeatability	6 mm ^{4) 5)}
Accuracy	± 10 mm ^{6) 7)}
Response time	1 ms ... 600 ms ⁸⁾
Measurement cycle time	0.195 ms

¹⁾ On reflective tape "Diamond Grade".

²⁾ On reflector PL880FS01.

³⁾ On reflector OP60.

⁴⁾ 6 % ... 90 % remission.

⁵⁾ Environmental conditions constant, min. warm-up time 30 min, average depth 1,024, statistical error 1 σ .

⁶⁾ 23 °C air temperature, 977 hPa, min. warm-up time 30 min.

⁷⁾ When operating in ambient temperatures between +40 °C ... +55 °C the accuracy can decrease by factor 2.5.

⁸⁾ Dependent on averaging method, averaging depth, timeout, baud rate, data output, and output format.

Average depth	1/16/64/256/1,024
Output time	1 ms ... 600 ms ⁸⁾
Light source	Laser, infrared
Laser class	1 (IEC 60825-1:2014, EN 60825-1:2014)
Typ. light spot size (distance)	20 mm (+ 5 x distance in m)

¹⁾ On reflective tape "Diamond Grade".

²⁾ On reflector PL880FS01.

³⁾ On reflector OP60.

⁴⁾ 6 % ... 90 % remission.

⁵⁾ Environmental conditions constant, min. warm-up time 30 min, average depth 1,024, statistical error 1 σ .

⁶⁾ 23 °C air temperature, 977 hPa, min. warm-up time 30 min.

⁷⁾ When operating in ambient temperatures between +40 °C ... +55 °C the accuracy can decrease by factor 2.5.

⁸⁾ Dependent on averaging method, averaging depth, timeout, baud rate, data output, and output format.

Interfaces

PROFIBUS DP	✓
Data transmission rate	12 MBaud

Ambient data

Electromagnetic compatibility (EMC)	EN 55011:1998 Kl. B, Gr.1 EN 6100-6-2:1999
Ambient temperature operation	-10 °C ... +55 °C -10 °C ... +75 °C, operation with cooling case
Ambient storage temperature	-25 °C ... +75 °C
Temperature drift	Typ. 0.6 mm/K ¹⁾ Typ. 0.3 mm/K ²⁾
Mechanical load	Shock: (IEC 60068-2-27, -2-29) Sine: (IEC 60068-2-6)

¹⁾ -10 °C ... 0 °C, +40 °C ... +55 °C.

²⁾ 0 °C ... +40 °C.

Classifications

ECl@ss 5.0	27270801
ECl@ss 5.1.4	27270801
ECl@ss 6.0	27270801
ECl@ss 6.2	27270801
ECl@ss 7.0	27270801
ECl@ss 8.0	27270801
ECl@ss 8.1	27270801
ECl@ss 9.0	27270801
ECl@ss 10.0	27270801
ECl@ss 11.0	27270801
ETIM 5.0	EC001825
ETIM 6.0	EC001825
ETIM 7.0	EC001825
UNSPSC 16.0901	41111613

Dimensional drawing (Dimensions in mm (inch))

DMT10-2-x2xx DML40-2-x2xx

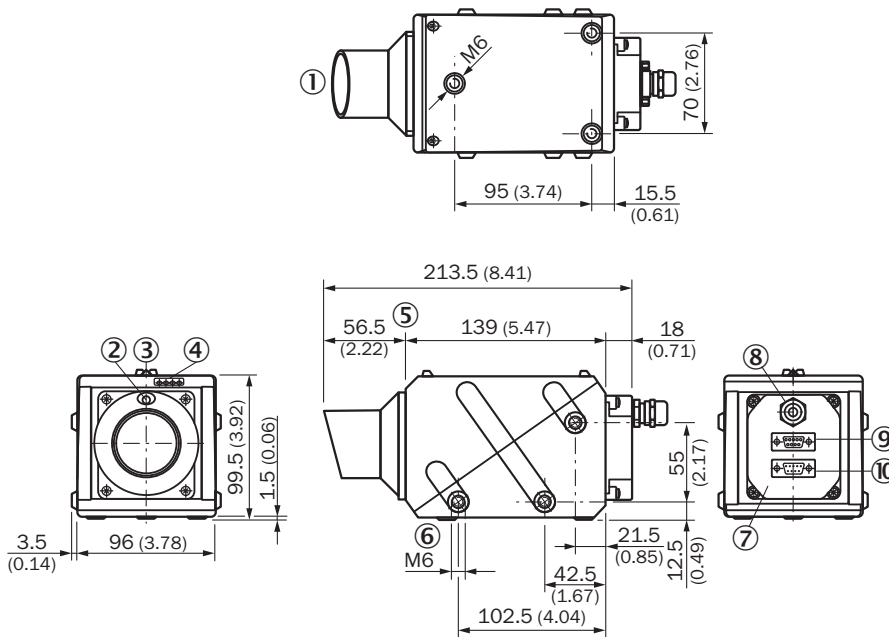

- ① Dust protection tube
- ② Laser pointer pilot light
- ③ Alignment sight
- ④ Function indicator
- ⑤ Zero level
- ⑥ Mounting hole M6 threaded - 6 mm deep
- ⑦ Connector cover
- ⑧ PG9
- ⑨ Sub-D, 9-pin
- ⑩ Sub-D, 9-pin

Connection type

DMxxx-2 RS-232/PROFIBUS connection type, connector

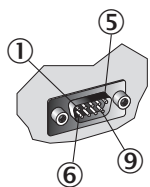

- ① nReset
- ⑤ M
- ⑥ NC = normally closed
- ⑨ NC = normally closed

DMxxx-2 RS-232/PROFIBUS connection type, female connector

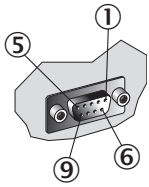

- ① NC = normally closed
- ⑤ M
- ⑥ L+
- ⑨ NC = normally closed

Connection type RS-232/PROFIBUS

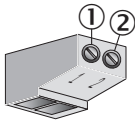

- ① Pin 1
- ② Pin 2

Connection diagram

Connection diagram DMxxx-2-x21x RS-232

RS-232

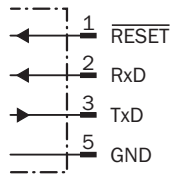

Connection type DMxxx-2 RS-232/PROFIBUS, socket

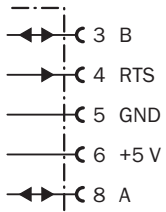

Connection type RS-232/PROFIBUS

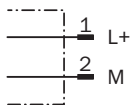

Adjustment possible

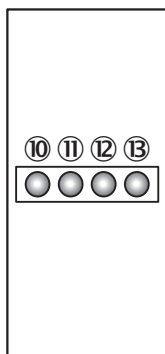

- ⑩ Q2 function indicator
- ⑪ Q1 function indicator
- ⑫ Operating indicator, green
- ⑬ Plausibility (measurement error) red

Recommended accessories

Other models and accessories → www.sick.com/DML

	Brief description	Type	Part no.
Terminal and alignment brackets			
	Alignment unit for DMT/DML, incl. mounting material, steel, zinc coated, mounting hardware included	BEF-GH-DME	5309130
Reflectors			
	Reflector plate, "diamond grade" reflective tape, 665 mm x 665 mm, base plate material: aluminum, screw connection, Screw-on, 4 hole mounting	PL560DG	1016806
Plug connectors and cables			
	Head A: female connector, D-Sub, 9-pin, straight Head B: Flying leads Cable: serial, unshielded, 3 m	YFDSA9-030XXXXLEBX	2020319

Recommended services

Additional services → www.sick.com/DML

	Type	Part no.
Warranty extensions		
<ul style="list-style-type: none"> • Product area: Identification solutions, machine vision, Distance sensors, Detection and ranging solutions • Range of services: The services correspond to the scope of the statutory manufacturer warranty (SICK general terms and conditions of purchase) • Duration: Five-year warranty from delivery date. 	Extended warranty for a total of five years from delivery date	1680671

SICK AT A GLANCE

SICK is one of the leading manufacturers of intelligent sensors and sensor solutions for industrial applications. A unique range of products and services creates the perfect basis for controlling processes securely and efficiently, protecting individuals from accidents and preventing damage to the environment.

We have extensive experience in a wide range of industries and understand their processes and requirements. With intelligent sensors, we can deliver exactly what our customers need. In application centers in Europe, Asia and North America, system solutions are tested and optimized in accordance with customer specifications. All this makes us a reliable supplier and development partner.

Comprehensive services complete our offering: SICK LifeTime Services provide support throughout the machine life cycle and ensure safety and productivity.

For us, that is “Sensor Intelligence.”

WORLDWIDE PRESENCE:

Contacts and other locations –www.sick.com