

## MC Toolkit (MCT404) User Manual

Doc. No.: 34-ST-25-50

Revision 4

Date: July 2017

# Copyright, Notices and Trademarks

Copyright 2017 by Honeywell International Inc.  
Revision 4, July 2017

While this information is presented in good faith and believed to be accurate, Honeywell disclaims the implied warranties of merchantability and fitness for a particular purpose and makes no express warranties except as may be stated in its written agreement with and for its customers.

In no event is Honeywell liable to anyone for any indirect, special or consequential damages. The information and specifications in this document are subject to change without notice.

Honeywell, PlantScape, Experion PKS, and **TotalPlant** are registered trademarks of Honeywell International Inc.

Other brand or product names are trademarks of their respective owners.

## Honeywell Process Solutions

1250 W Sam Houston Pkwy S

Houston, TX 77042

# About This Document

## Abstract

This document describes how to use MC Toolkit product, which consists of MC Toolkit application software and FDC application software.

## Revision Information

Document Details	Release Number	Publication Date
MC Toolkit (MCT404) User Manual		<b>34-ST-25-50</b>
New	Revision 1	February 2014
COM4 update	Rev.2	May 14
STT 850 / STT 750 added	Rev.3	June 2016
DD information updates	Rev.4	July 2017

## References

The following list identifies all documents that may be sources of reference for material discussed in this publication.

Document Title

## Support and contact info

### United States and Canada

- Contact: Honeywell Process Solution
- Global Technical Support - Phone: 001-800-423-9883
  - Customer Service (HFS) - Phone: 001-800-343-0228
  - Outside United States - Phone: 001-215-641-3610
- Calls are answered by dispatcher between 6:00 am and 4:00 pm Mountain Standard Time. Emergency calls outside normal working hours are received by an answering service and returned within one hour.
- Email support: Sales: [FP-Sales-Apps@Honeywell.com](mailto:FP-Sales-Apps@Honeywell.com)  
Technical Assistance: [hfs-tac-support@honeywell.com](mailto:hfs-tac-support@honeywell.com)
- Mail: Honeywell Process Solutions  
1250 W Sam Houston Pkwy S,  
Houston, TX 77042

**For other contact details in Europe, Asia, North and South Americas refer to the back page.**

### World Wide Web

Honeywell Process Solutions Support Online:

[www.honeywellprocess.com/](http://www.honeywellprocess.com/)

### Elsewhere











Call your nearest Honeywell office.

### Training Classes

[www.honeywellprocess.com/en-US/training](http://www.honeywellprocess.com/en-US/training)

## Symbol Definitions

The following table lists those symbols used in this document to denote certain conditions.

Symbol	Definition
	<p><b>CAUTION:</b> Indicates a potentially hazardous situation which, if not avoided, may result in minor or moderate injury. It may also be used to alert against unsafe practices.</p> <p><b>CAUTION</b> symbol on the equipment refers the user to the product manual for additional information. The symbol appears next to required information in the manual.</p>
	<p><b>WARNING:</b> Indicates a potentially hazardous situation, which, if not avoided, could result in serious injury or death.</p> <p><b>WARNING</b> symbol on the equipment refers the user to the product manual for additional information. The symbol appears next to required information in the manual.</p>
	<p><b>WARNING, Risk of electrical shock:</b> Potential shock hazard where HAZARDOUS LIVE voltages greater than 30 Vrms, 42.4 Vpeak, or 60 VDC may be accessible.</p>
	<p><b>ESD HAZARD:</b> Danger of an electro-static discharge to which equipment may be sensitive. Observe precautions for handling electrostatic sensitive devices.</p>
	<p><b>Protective Earth (PE) terminal:</b> Provided for connection of the protective earth (green or green/yellow) supply system conductor.</p>
	<p><b>Functional earth terminal:</b> Used for non-safety purposes such as noise immunity improvement. NOTE: This connection shall be bonded to Protective Earth at the source of supply in accordance with national local electrical code requirements.</p>
	<p><b>Earth Ground: Functional earth connection.</b> NOTE: This connection shall be bonded to Protective Earth at the source of supply in accordance with national and local electrical code requirements.</p>
	<p><b>Chassis Ground:</b> Identifies a connection to the chassis or frame of the equipment shall be bonded to Protective Earth at the source of supply in accordance with national and local electrical code requirements.</p>
	<p>The Factory Mutual® Approval mark means the equipment has been rigorously tested and certified to be reliable.</p>
	<p>The Ex mark means the equipment complies with the requirements of the European standards that are harmonised with the 94/9/EC Directive (ATEX Directive, named after the French "ATmosphere EXplosible").</p>

## Acronyms and definitions

**Table 1 Acronyms and Definitions**

Term	Description
DD	Device Description File
DDL	Device Description Language
DE	Digitally Enhanced
Device	The hardware that is responsible for sensing the conditions present in a process and communicating this information to the Pocket PC. These conditions may include pressure, temperature. Examples of devices include the ST, STT. Device is also referred to as a Field Instrument
Download	The process of sending data from a Pocket PC to a Device
EDDL	Electronic Device Description Language
Export	Writing / saving parameters into a file
FDC	Field Device Communicator
FDM	Field Device Manager
HCF	HART Communication Foundation
Import	Reading / loading parameters from a file
MCT	Multi Communication Toolkit (MCT404) product that includes MC Toolkit application and FDC application
MCT404	Options include ruggedized version with no approvals, Intrinsically-safe version with Zone1 approvals
Modem	Honeywell HART / DE modem that implements interfaces to the HART and DE network
Offline	The condition present when the MC Toolkit is running but is <b>not</b> connected to a live <i>device</i> .
Online	The condition present when the MC Toolkit is running and is connected to a live <i>device</i> .
Parameter	A piece of information representing a single unit of data in a <i>device</i> or database
PPC	Pocket PC
Record	A Set of Configuration parameters that consists of Device Type, Bus Type, Tag ID, Manufacturer, LRV, URV, Transfer Function and other Parameters
ST	Smart Transmitter, pressure - a Honeywell Field Instrument.
STT	Smart Temperature Transmitter – a Honeywell Field Instrument
Upload	The process of sending data from a Device to a Pocket PC
XML	Extensible Markup Language. A file type that provides a format for describing structured data from any application in a standard consistent way

# Contents

<b>Support and contact info.....</b>	<b>iv</b>
<b>1. INTRODUCTION.....</b>	<b>1</b>
<b>1.1 Overview of MC Toolkit .....</b>	<b>1</b>
Purpose/Scope .....	1
Product Description .....	2
MCT404.....	2
Software components.....	2
Procedural Considerations .....	3
<b>1.2 Transmitter Type and Communication Mode.....</b>	<b>3</b>
<b>1.3 Type of Procedure.....</b>	<b>4</b>
<b>1.4 Prerequisites.....</b>	<b>4</b>
Special Equipment and/or Environment for Calibration .....	4
Software Environment .....	4
<b>2. BEFORE YOU BEGIN .....</b>	<b>5</b>
<b>2.1 Calibration requirements.....</b>	<b>5</b>
Input calibration .....	5
Output Calibration.....	5
<b>2.2 Transmitter/Communication characteristics.....</b>	<b>5</b>
Digital to Analog conversion and transfer .....	5
Honeywell Transmitter (Analog Mode) .....	5
Honeywell transmitter analog value scaling.....	8
Honeywell transmitter output-Digital enhanced mode .....	9
<b>2.3 Wi-Fi Connection Support.....</b>	<b>12</b>
<b>3. GETTING STARTED.....</b>	<b>15</b>
<b>3.1 MC Toolkit Installation.....</b>	<b>15</b>
<b>3.2 MC Toolkit Assembly.....</b>	<b>16</b>
MCT404 assembly.....	16
<b>3.3 Safety instructions .....</b>	<b>18</b>
For MCT404 .....	18
<b>3.4 Battery and Power Supply.....</b>	<b>19</b>
<b>3.5 Start up, Shutting down the MC Toolkit.....</b>	<b>20</b>
<b>3.6 Application icons .....</b>	<b>20</b>
<b>3.7 Connecting to a device through MC Toolkit (MCT404) .....</b>	<b>21</b>
Wiring diagrams .....	22
<b>3.8 Connecting MC Toolkit to a PC.....</b>	<b>23</b>
Connecting MCT404.....	23
<b>3.9 Types of input methods.....</b>	<b>23</b>
Input dialog in FDC.....	27
MCT404 Function Keys .....	28

<b>4.</b>	<b>MANAGING HART DEVICES USING FDC APPLICATION SOFTWARE</b>	<b>29</b>
4.1	<b>Starting FDC</b> .....	<b>29</b>
	Generic layout of user interface of FDC .....	29
4.2	<b>Overview of FDC homepage</b> .....	<b>30</b>
	Settings .....	31
	Manage DDs .....	32
	Online configuration .....	32
	Offline configuration .....	32
4.3	<b>Customizing the settings</b> .....	<b>33</b>
	Modifying device identification settings .....	33
4.4	<b>Managing DD files</b> .....	<b>35</b>
4.5	<b>Overview of device configuration</b> .....	<b>37</b>
4.6	<b>Online configuration</b> .....	<b>38</b>
	Overview of Device Homepage.....	38
	Tabs on the Device Home page.....	40
	Viewing different type of variables.....	43
	Searching for an item .....	46
	Device Health Indicator and Details .....	47
	Graphical items in a device interface .....	47
	Executing methods on a device .....	55
	Saving device history .....	56
	Exporting device history records to FDM.....	57
	Exporting device history records to Documint .....	58
	Custom Views .....	58
4.7	<b>Offline configuration</b> .....	<b>60</b>
	Overview .....	60
	Importing offline configuration .....	60
	Deleting offline configuration .....	61
	Downloading an offline configuration .....	61
<b>5.</b>	<b>MANAGING DE DEVICES USING MC TOOLKIT SOFTWARE..</b>	<b>63</b>
5.1	<b>Starting MC Toolkit application</b> .....	<b>63</b>
5.2	<b>Overview of MC Toolkit Homepage</b> .....	<b>63</b>
	Online and Offline Modes.....	63
5.3	<b>MC Toolkit Application Software Display Conventions</b> .....	<b>65</b>
	Navigation .....	65
	Menu Bar.....	65
	File Menu .....	67
	Modem Menu .....	68
	Help Menu.....	69
	Data Entry and Display .....	70
5.4	<b>Overview of device configuration</b> .....	<b>70</b>
5.5	<b>Online configuration</b> .....	<b>71</b>
	Detecting and loading a device .....	71
	Online Mode Introduction .....	71
	Summary of Operating Procedures.....	73
	Procedural Considerations .....	75
5.6	<b>How to view the Saved Configuration file and Import to Excel</b> .....	<b>94</b>
	How to Import the data from the xml file to Excel? .....	97



<b>5.7</b>	<b>Offline Configuration .....</b>	<b>99</b>
	Save to File in Offline Mode .....	105
	Template File.....	106
	Download in Offline mode .....	107
	Download Parameter List .....	108
	DE Fields and Values .....	110
<b>5.8</b>	<b>Reference Data .....</b>	<b>112</b>
	Glossary .....	112
	Honeywell DE Fields and Values .....	114
	STT850 / STT750 Local Display Screen1 Configuration using MCT404 .....	118
<b>5.9</b>	<b>XML Database (Samples) .....</b>	<b>121</b>
<b>6.</b>	<b>TROUBLESHOOTING .....</b>	<b>123</b>
<b>6.1</b>	<b>MC Toolkit troubleshooting scenarios.....</b>	<b>123</b>
	MCT404.....	123
<b>6.2</b>	<b>FDC application software troubleshooting scenarios.....</b>	<b>124</b>
<b>6.3</b>	<b>MC Toolkit application software troubleshooting scenarios .....</b>	<b>128</b>
	MC TOOLKIT ERROR MESSAGES.....	129
	DE Device error messages.....	133
	Offline configuration Error Messages .....	135
<b>7.</b>	<b>MC TOOLKIT MAINTENANCE.....</b>	<b>139</b>
<b>7.1</b>	<b>MCT404 battery replacement .....</b>	<b>139</b>
	Battery Status.....	139
	Battery Replacement .....	139
	Charge the Battery .....	139
	Replace the Battery .....	139
<b>7.2</b>	<b>SD card replacement .....</b>	<b>141</b>
	MCT404 SD Card Replacement.....	141
<b>8.</b>	<b>APPENDIX A: APPLICATION NOTES.....</b>	<b>143</b>
<b>8.1</b>	<b>Application Notes.....</b>	<b>143</b>
	Synchronization between PDA and PC .....	143
	File Transfer .....	147
	Using Infrared Red Port for OneWireless Devices .....	148
<b>9.</b>	<b>APPENDIX B: .....</b>	<b>152</b>
<b>9.1</b>	<b>MCT Power Save Guidelines.....</b>	<b>152</b>
<b>10.</b>	<b>APPENDIX C: REPLACEMENT PARTS .....</b>	<b>153</b>
<b>10.1</b>	<b>MCT404 Accessories &amp; Spare Parts.....</b>	<b>153</b>

## Tables

Table 1 Acronyms and Definitions .....	vi
Table 2 Components of MCT404 assembly.....	17
Table 3: MCT404 Function Keys .....	28
Table 4 Generic UI elements .....	30
Table 5 FDC homepage elements .....	31
Table 6 Device homepage elements .....	39
Table 7 Device health status.....	39
Table 8 Device configuration screen elements.....	41
Table 9 Device configuration screen icons .....	42
Table 10 Tool bar on graph/chart page.....	52
Table 11 DE Displays / Tasks Summary .....	73
Table 12 DE Upload Procedures .....	75
Table 13 DE Main Menu Procedures.....	77
Table 14 Input Calibration (DE Transmitters) – .....	83
Table 15 Output Calibration - Loop Test.....	88
Table 16 DE Output Calibration - Trim DAC Current.....	90
Table 17 DE Calibration - Apply Values.....	92
Table 18 MCT404 Replacement Parts.....	153

## Figures

Figure 1-1 MCT404 Ruggedized and Zone 1 Intrinsically safe models .....	2
Figure 2-1 Honeywell ST 3000/ ST 800 Smart Transmitter - Analog mode .....	6
Figure 2-2 Honeywell Analog Value Scaling .....	8
Figure 2-3 Honeywell DE Mode Value Scaling.....	10
Figure 2-4 Honeywell (HART) Transmitter Diagram .....	11
Figure 2-5 HART Point-point and Multi-Drop Value Scaling .....	11
Figure 3-1 MCT404 assembly .....	16
Figure 3-2 Start Menu .....	20
Figure 3-3 Connecting to a device through MCT404 .....	21
Figure 3-4 MCT404 terminal connections to HART/DE device .....	22
Figure 3-5 MCT404 terminal connections to HART Device .....	22
Figure 3-6 Virtual keypad.....	23
Figure 3-7 Block Recognizer .....	24
Figure 3-8 Letter recognizer .....	25
Figure 3-9 Freehand recognition .....	26
Figure 3-10 Alphanumeric keypads.....	27
Figure 4-1 Generic layout of user interface .....	29
Figure 4-2 FDC homepage .....	30
Figure 4-3 Device homepage .....	38
Figure 4-4 Device configuration screen.....	41
Figure 5-1 Menu Tree - Honeywell DE Displays .....	72
Figure 5-2 Offline Browse / Open File dialog.....	100
Figure 5-3 MC Toolkit Options.....	101
Figure 5-4 DE device .....	102
Figure 5-5 STT25D and 25M, STT350 models .....	103
Figure 5-6 STT25T model.....	103
Figure 5-7 ST 3000 / ST 800 models .....	103
Figure 5-8 STT25M and 25D models .....	104
Figure 5-9 ST3000 DE.....	104
Figure 5-10 DE STT350.....	104
Figure 5-11 Save As File dialog .....	105
Figure 5-12 Honeywell DE Save Template Screen.....	106
Figure 5-13 Offline Honeywell DE Save Template as working file.....	106
Figure 5-14 Download in Offline Mode .....	107
Figure 7-1 Remove Handstrap .....	140
Figure 7-2 Remove Battery Cover.....	140
Figure 7-3 SD Card Replacement .....	142
Figure 8-1 Screen Y.....	143
Figure 8-2 Screen X.....	145
Figure 8-3 ActiveSync/Mobile Device Center file transfer .....	147
Figure 8-4 MCT404 Infrared port location .....	148



# 1. Introduction

## 1.1 Overview of MC Toolkit

### Purpose/Scope

This manual is intended to facilitate the use of the Honeywell MC Toolkit communications tool. It is assumed that you are skilled in the use and maintenance of process transmitters in process control, or that you are under direct supervision of others with the appropriate skills.

The MC Toolkit, with MC Toolkit Application Software and FDC Application Software, enables communication with several types of smart transmitters (pressure, temperature, etc) that are available for use in the process control industry.

The emphasis of the information in this manual is directed primarily on the features and use of the MC Toolkit in performing common maintenance tasks relating to transmitter devices, rather than on the features and installation of specific transmitter devices.

It is recommended that you should have the appropriate manuals available for specific transmitter devices.

This manual includes information of two types:

- background material that enables a skilled user to select the appropriate procedures in this manual and to apply them in the appropriate sequence, and
- detailed descriptions of the MC Toolkit regarding functions, features, and procedures for applying them

## Product Description

The Honeywell Multi Communication (MC) Toolkit is a handheld communication package that enables convenient and reliable communications with smart field devices such as valves, actuators, transmitters etc. MC Toolkit is a smart solution for configuring, calibrating, monitoring, and diagnosing the devices supporting Honeywell Digitally Enhanced (DE) or HART communication protocols.

The MC Toolkit is available in high level model MCT404

## MCT404

The MCT404 has following options:

- Ruggedized version: Environmentally hardened with no approvals.
- Zone 1 approvals: Intrinsically-safe version available with FM Class I, Div 1, IECEx and ATEX Zone 1 approvals.



**Figure 1-1 MCT404 Ruggedized and Zone 1 Intrinsically safe models**

It includes the following components:

- A PDA with integrated DE/HART modem
- Honeywell MC Toolkit application software (CD ROM)
- Honeywell FDC application software (CD ROM)
- Test leads for the electrical connection from the PDA to the field device
- Connector cables for connecting the PDA to the PC

## Software components

The Honeywell MC Toolkit consists of two software applications:

- The MC Toolkit application software is used for configuring, calibrating, monitoring, and diagnosing the Honeywell Digital Enhanced (DE) devices.
- Field Device Configurator (FDC) application software is used for configuring, calibrating, monitoring, and diagnosing HART devices. FDC uses the IEC 61804-3 EDDL standard specification for providing an open solution for supporting any HART device with a registered DD file and or Generic DD with HART Communication Foundation (HCF).  
If Generic DD is used then HART universal commands are supported. If the device vendor has qualified their DD with the HART Foundation, the device description is assured of being compliant with the HON FDC 2.X Application as long as the device can be loaded into MCT404 using the device specific DD.

### Procedural Considerations



#### **CAUTION! WARNING!**

In some cases, the use of a field communicator with a transmitter that is connected on-line can have an adverse effect on process operations.

Before using the MC Toolkit, be certain that you know the potential consequences of each procedure, and that you use the appropriate safeguards to prevent problems. For example, if the transmitter is an element of a control loop, the loop should be placed in the manual operating mode, and alarms and interlocks ("trips") should be disabled as appropriate before beginning the procedure.

The primary factors to be considered are separated into three categories under the following three headings.

The information under the following headings is intended as background for use of the DE Procedures and HART Procedures, which are given in separate sections of this manual.

## 1.2 Transmitter Type and Communication Mode

The MC Toolkit can be used with various types of field transmitters, most of which can be operated in more than one mode.

- Honeywell DE transmitter operating in Smart Analog Mode
- Honeywell DE transmitter operating in Digital Enhanced (DE) Mode
- Honeywell (and other) HART transmitter operating in point-to-point (Analog w/ HART digital mode)
- Honeywell (and other) HART transmitter operating in multi-drop (HART-only digital mode)

The salient characteristics of each item listed, and the implications of each characteristic in procedures are described under Transmitter/Communications Characteristics

## 1.3 Type of Procedure

The MC Toolkit is designed to provide these basic functions:

- Configuration
- Calibration
- Monitoring
- Diagnostics

Depending on combinations of factors such as transmitter type, and communications mode, some procedures such as monitoring the performance of a transmitter can be straightforward and innocuous, but in some cases can also require special preparation and precautions.

## 1.4 Prerequisites

### Special Equipment and/or Environment for Calibration

Typically, a smart transmitter delivered by a major manufacturer today is designed to provide a high degree of precision throughout its operating range, and has been calibrated to a high level of accuracy that is not easy to duplicate in your plant process areas. Moreover, the design, materials, and manufacturing process employed will ensure that the instrument will stay within calibration limits for an extended period.

Typically, calibration of a process-connected transmitter will degrade, rather than augment, the capability of a smart transmitter. For this reason, the calibration procedures in this MC Toolkit User Manual include a recommendation that the transmitter is removed from service and is calibrated only in a controlled laboratory environment, using equipment whose precision is certified.

### Software Environment

MC Toolkit runs on the Windows Embedded Handheld 6.5 operating system. A basic familiarity with the OS and the PDA functions is expected.

If you are running Windows XP, download ActiveSync/Mobile Device Center 4.1 or above from the Microsoft Web site and install it on your PC.

If you are running Windows Vista or Windows 7 download Windows Mobile Device center version 6.1 or above from the Microsoft Web site and install it on your PC.

SD Card: At least 1GB memory on the SD Card. Use a SD™ card to increase file storage and install software. The MCT404s support an optional 32 GB maximum capacity microSD card. The SD card is formatted to FAT or FAT32. The MCT404 is despatched with 2GB of memory

**Regional Settings:** Before starting the applications, set the Regional Settings to English (United States). To check the Regional Settings of your PDA, select Start/Settings/System/Regional Settings. Make sure it is set to English (United States).



## 2. Before you begin

### 2.1 Calibration requirements

#### Input calibration

Input calibration of pressure transmitters should be done only when necessary, and should be done only under conditions that will ensure accuracy:

- The transmitter should be taken out of service, and should be moved to an area with favorable environmental conditions: clean, dry, and temperature-controlled.
- The source for the input pressure must be very precise, and certified for correct operation.
- The procedures should be done by qualified personnel.

Details of requirements and procedure are given in Table 14.

#### Output Calibration

The *Loop Test* procedure is intended as a check for continuity and condition of components in the output current loop. The Loop Test procedure is given in Table 15.

The *Trim DAC Current* procedure calibrates the output of the Digital to Analog converter for minimum (0%) and maximum (100%) values of 4 mA and 20 mA, respectively. This procedure is used for transmitters operating on-line in analog mode, to ensure proper operation of the transmitter with all associated circuit components (wiring, power supply, control equipment, etc). It is necessary to use precision test equipment (an ammeter or a voltmeter in parallel with precision resistor). The Trim DAC procedure is given in Table 16.

The *Apply Values* procedure uses actual Process Variable input levels for calibrating the range of a transmitter. To measure a liquid level for example, a sight-glass can be used to determine the minimum (0%) and maximum (100%) level in a vessel. The Process Variable is carefully adjusted to stable minimum and maximum levels, and the LRV and URV values are then set by commands from the MC Toolkit. The DE Apply Values procedure is given in Table 17.

### 2.2 Transmitter/Communication characteristics

#### Digital to Analog conversion and transfer

The characteristics of a typical Honeywell Smart Pressure Transmitter (DE Protocol) are summarized in Figure 2-1 through Figure 2-5, following.

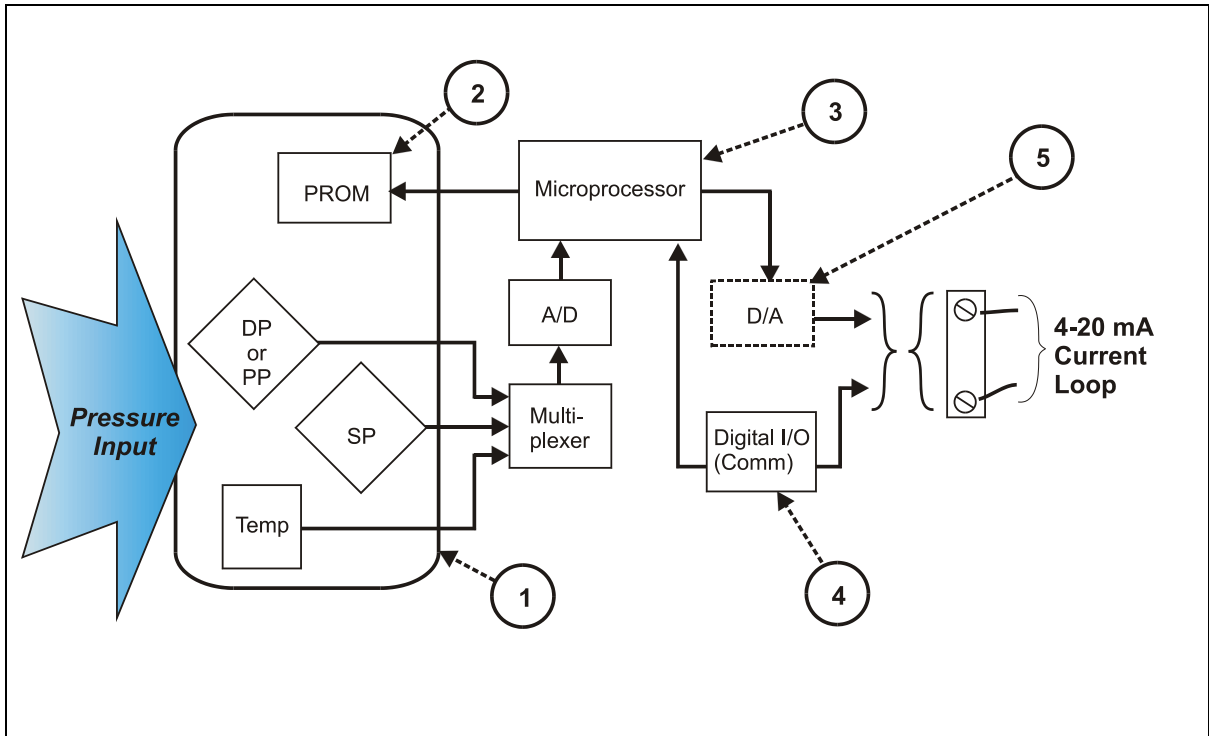
#### Honeywell Transmitter (Analog Mode)

##### *Analog-to-Digital Sensing*

As indicated by key number (1) in Figure 2-1, the sensor is a sealed assembly that typically includes three separate sensors: Differential Pressure (DP), Static Pressure (SP) and Temperature (Temp).

##### **Input Characterization**

The sensor also includes a PROM, (2), which is Non-Volatile Memory (NVM) that stores "characterization" constants written at the factory, and calibration constants, which can be written at the factory and/or at the user's site. The data in NVM is used in an algorithm in the microprocessor, (3), which is executed continuously to calculate the input value.



**Figure 2-1 Honeywell ST 3000/ ST 800 Smart Transmitter - Analog mode**

The characterization constants, which are written at the factory, are derived from highly precise testing of the sensor's response over a range of temperatures, and from the Lower Range Limit (LRL) to the Upper Range Limit (URL) of the sensor. The purpose of the characterization constants is to compensate for very small inaccuracies in the sensor that are introduced by variations inherent in construction materials, and to ensure that the calculated input is a high-fidelity representation of the analog input (linear or square root), with a precise "zero" reference.

#### **Input Calibration ("Corrects")**

To optimize accuracy, the PROM includes storage for calibration constants: Correct Input Zero, Correct LRV, and Correct URV.

The corrects constants provide for optimum accuracy in that they enable fine-tuning of the input calculations, by first correcting at zero input, then bounding the input calculations at your operating range. That is, corrections are applied at the Lower Range Value (LRV) and the Upper Range Value (URV).

Factory calibration can be specified in the purchase order. Also, if precision equipment, suitable environment, and required skill are available at your site, input calibration can be done locally.

#### **Reset Corrects**

In some cases, the calibration procedure yields unsatisfactory results such that the Corrects constants must be removed from memory. The Reset Corrects erases all three corrects constants, so that only the factory-written characterization constants will be retained in the PROM.

#### **Digital Communication Path**

As indicated at key number (4) in Figure 2-2, the Honeywell Smart Transmitter includes a path for digital communications between the sensor (via the microprocessor) and the 4-20 mA current loop that connects the transmitter to external communications devices such as process control equipment ("receiver") and/or to a MC Toolkit.

### **Digital to-Analog Conversion and Transfer**

The digital-to-analog converter (D/A) shown at key number (5) in Figure 2-1 is shown as a box with a dotted line to indicate that analog output mode is a user-selectable feature, for use in an application whose receiving equipment requires an analog input.

Note that the Digital I/O (Comm) (communications) box (4) is shown in Figure 2-1 with solid line to indicate that the digital communications path is available at all times, even when analog mode is selected.

### **Honeywell Transmitter Output - Analog Mode**

The diagram in Figure 2-2 provides an overview of a Honeywell transmitter operating in the analog mode.

#### **Analog (PV Signal) Output**

The vertical scale at the left of Figure 2-2 is an example of the available range (LRL to URL) of a pressure transmitter sensor as built and characterized at the factory. The area of this scale that is highlighted in white represents the configured process operating range (LRV to URV) - in this case, from 100 in H<sub>2</sub>O to 225 in H<sub>2</sub>O.

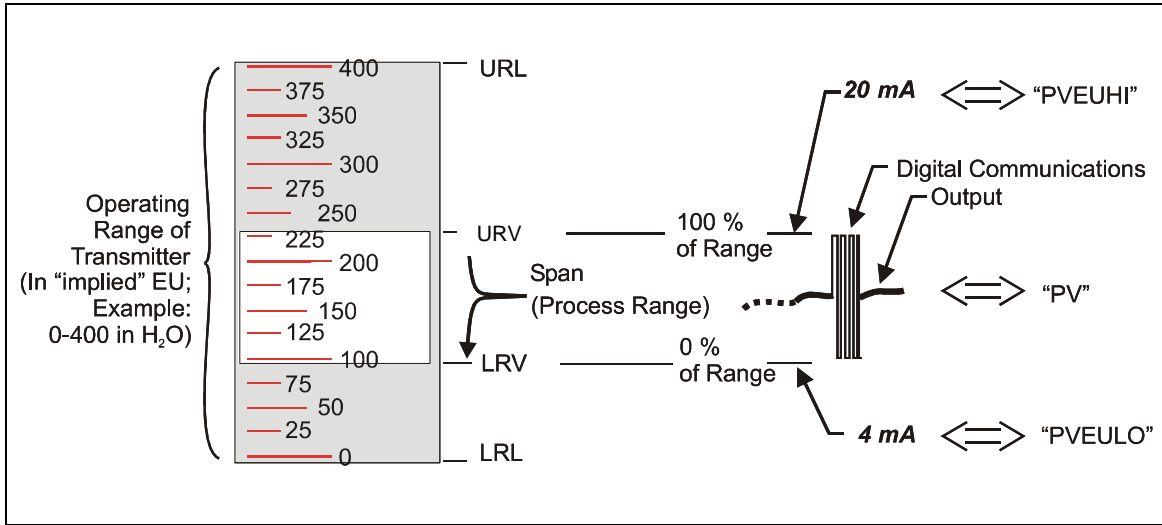
Note that Engineering Units (EUs) shown in Figure 2-2 are included here only for reference. The transmitter does not perform any conversion of the base units' value to Engineering Units. All conversion to EUs is performed in the MC Toolkit and/or in other receiving devices such as operating panels associated with control equipment. Default conversion is to inches-H<sub>2</sub>O @39°F.)

The output of a Honeywell transmitter operating in the analog mode is a scaled value (0% - 100%) of current (4 mA to 20 mA), whose lower and upper limits correspond to the configured operating range (LRV-URV), respectively.

At the right of Figure 2-2, "PVEULO", "PV", and "PVEUHI" are examples of parameter names that appear on Honeywell control equipment, which are used as follows.

<b>Parameter Name</b>	<b>Parameter Description</b>	<b>Display Examples</b>
PVEULO	Process Value , Engineering Units, Low	PVEULO 100 in H2O
PV	Process Value	PV 175 in H2O
PVEUHI	Process Value , Engineering Units, Low	PVEUHI 225 in H2O


## Honeywell transmitter analog value scaling



**Figure 2-2 Honeywell Analog Value Scaling**

### Digital (Communications Signal) Input/Output

As indicated at the right of Figure 2-2, communications between the MC Toolkit and the Honeywell Smart Transmitter consist of digital pulse strings, with rapid transitions of current level between (approximately) 4 mA and 20 mA.

	<p><b>CAUTION:</b></p> <p>These rapid transitions provide for effective communications, but will interfere adversely with a transmitter operating on-line in a control loop.</p> <p>The MC Toolkit communicates digitally; exercise caution and good judgment when connecting the unit to an on-line transmitter operating in the analog mode.</p>
---	--

## Honeywell transmitter output-Digital enhanced mode

Most of the operation of the Honeywell Smart Pressure Transmitter Digital Enhanced (DE) mode is similar to that of operation in the analog mode. The essential characteristics of operation in DE mode are shown in Figure 2-3 Honeywell DE Mode Value Scaling

As indicated at the right of Figure 2-3 Honeywell DE Mode Value Scaling, output values of process variables, as well as digital communications, are transferred to a receiving device digitally. The digital coding is Honeywell proprietary, which requires the use of DE-capable Honeywell control equipment.

The use of DE mode offers several advantages:

process safety	Unlike in the analog mode, communications devices do not "bump" the value of the PV.
accuracy is retained with less maintenance	Digital communications are relatively immune to small variations in circuit resistance or supply voltage.
facilitates maintenance tasks	Honeywell control systems include operating displays that enable direct communication with transmitters operating in DE mode.



### CAUTION:

Although it is not necessary to put a control loop in manual before communicating with a transmitter operating in DE mode, caution is required if there is any potential for error in identifying operating mode.

## Honeywell HART Transmitters

Transmitters with HART capability have features that vary among manufacturers and with the characteristics of specific devices. The FDC application supports the HART Universal, Common Practice, and Device Specific Commands that are implemented in Honeywell HART transmitters

As the diagram in Figure 2-4 shows, the Honeywell HART Transmitter is virtually identical to non-HART transmitters, except that the HART version includes a Digital I/O Modulator/Demodulator block (key number (4) instead of the Honeywell DE communications block.

As indicated in Figure 2-5, the output of the HART includes two primary modes:


- Point-to-Point Mode, in which one transmitter is connected via a two-conductor, 4-20 mA current loop to one receiver.
- Multi-Drop Mode, in which several transmitters are connected via a two-conductor network to a multiplexed receiver device.

In point-to-point mode, the value of the primary PV is represented by a 4-20 mA current loop, almost identical to that of the Honeywell Transmitter operating in analog mode. In this case however, the analog signal is modulated by Frequency Shift Keying (FSK) methods, using frequencies and a current amplitude that do not affect analog sensing at the receiver.

Note that the accuracy of the analog level must be precisely controlled for accurate sensing, but that HART communications will not "bump" the process variables.

In multi-drop mode, up to 16 transmitters in HART 5 (addresses 0-15) and up to 64 transmitters in HART6/7 (addresses 0-63) can exist on the two-conductor network, which precludes analog transmission

methods. In this case, the same FSK modulation method is used for conveying levels of PV (and other variables) and also for communications.

	<p><b>CAUTION:</b></p> <p>Before connecting to a HART transmitter, ensure that the MC Toolkit is not set up for DE communications, whose current amplitude can "bump" process variables in either point-to-point mode or in multi-drop mode.</p>
---	--

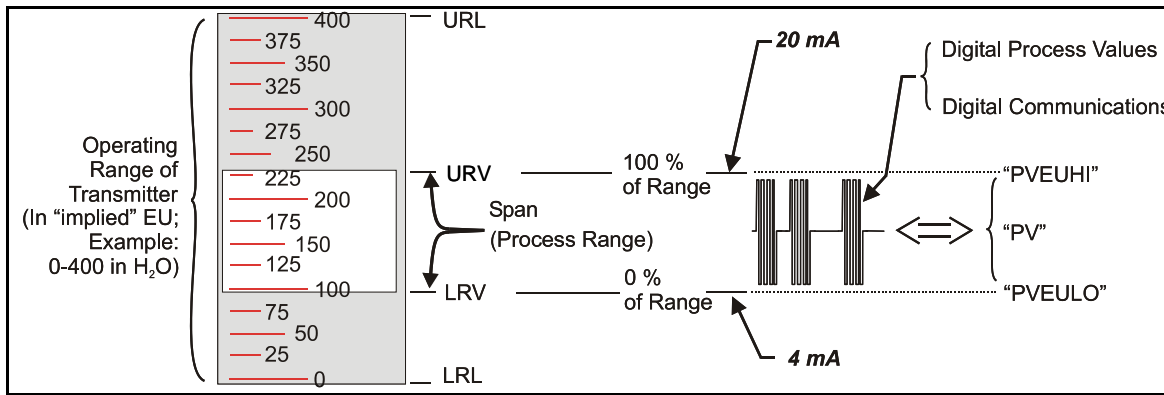
**Non-Honeywell HART Transmitters and Devices**

HART-capable transmitters from any manufacturer and for any specific purpose are designed to common-agreement standards that provide for inter-operability.

Guidelines published by the HART Communication Foundation enables manufacturers to design devices that communicate via a set of standard commands and responses.

The FDC application software supports the HART Revision 5.0, 6.0 and 7.0 commands that are exposed through the HART Communication Foundation Device Description files. For more information, refer to tables in the Reference Data section 5.8.

The FDC uses Device Descriptions stored in the Pocket PC to communicate to all universal, common and device specific commands. MC Toolkit will come with all HART Registered (updated once per quarter) Device Descriptions pre-loaded.



**Figure 2-3 Honeywell DE Mode Value Scaling**

2. Before you begin  
 2.2. Transmitter/Communication characteristics

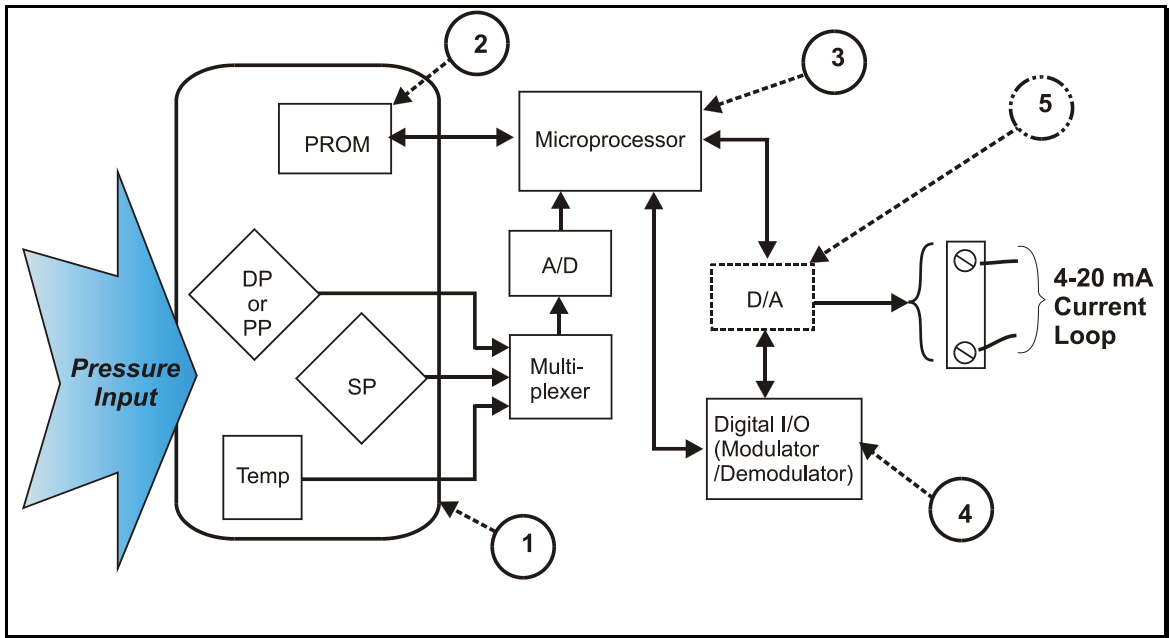


Figure 2-4 Honeywell (HART) Transmitter Diagram

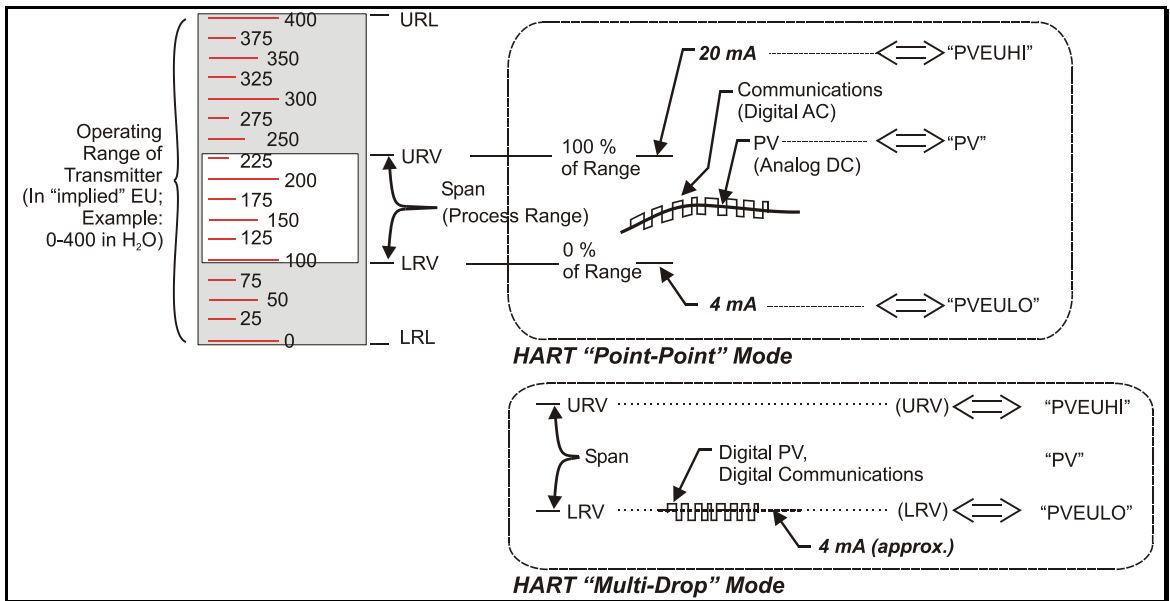


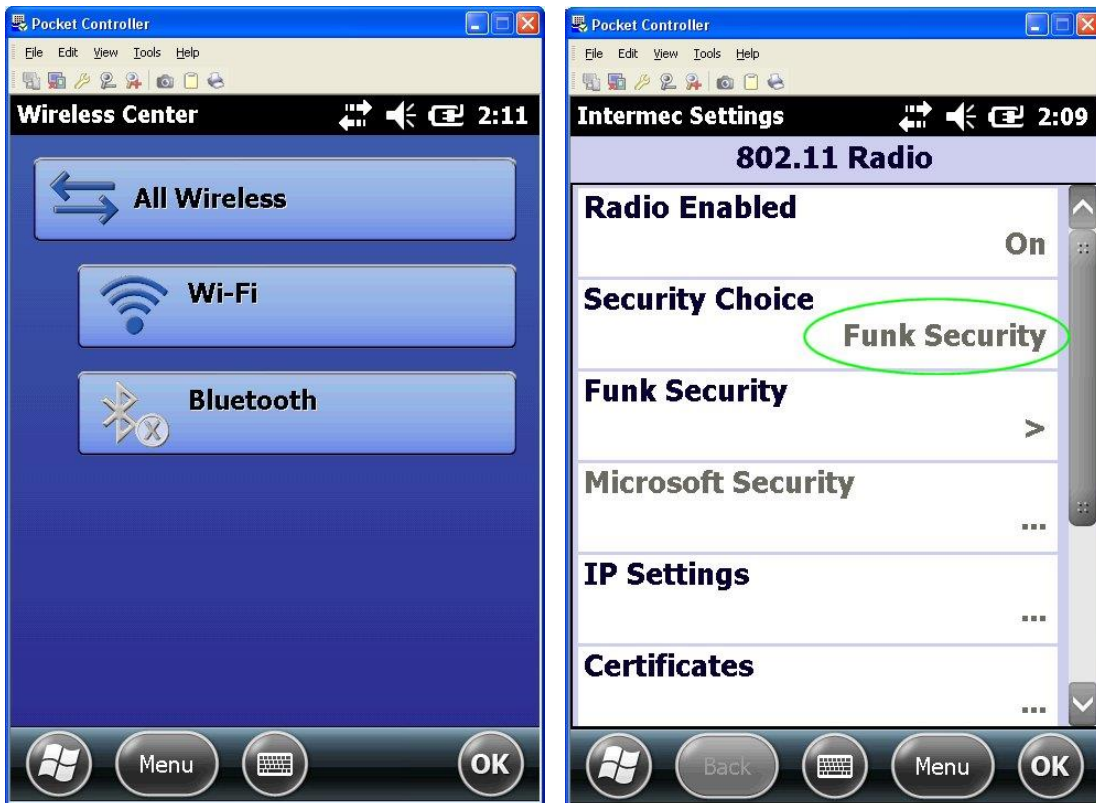
Figure 2-5 HART Point-point and Multi-Drop Value Scaling

## 2.3 Wi-Fi Connection Support

MCT404 is sold with or without Wi-Fi option.

This section shows you how to connect the handheld to Wi-Fi and then connect to the Internet for example to download the DD files for any Transmitter or connect to a network printer etc.

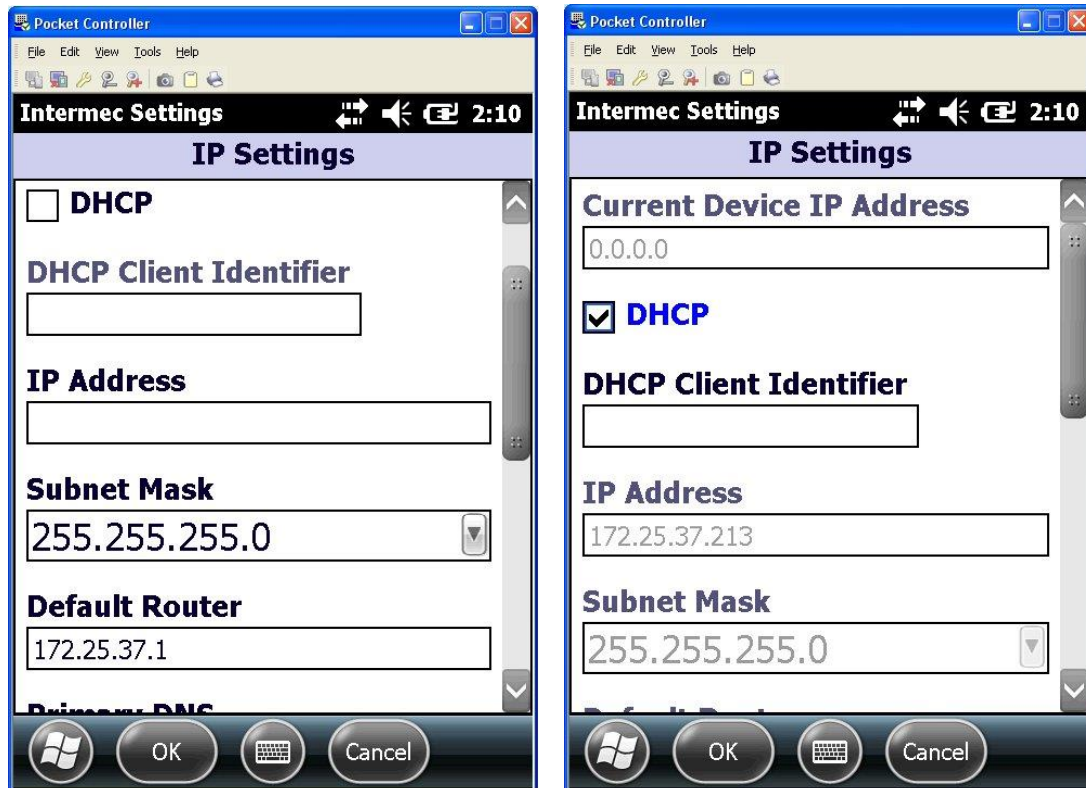
1. Make sure the Wi-Fi setting is Turned on



2. Set the Security Choice to “Func Security”



3. The IP address will be detected automatically. If it is not detected, then find the IP address from your network provider and enter it in the IP Address and Subnet Mask field.



4. Select OK. Once the IP address is entered, you can connect to the network with or without DHCP Enabled.



## 3. Getting Started

### 3.1 MC Toolkit Installation

MC Toolkit software is fully loaded in the factory on all new orders.

The installation instruction for the above process is in document 34-ST-33-59.

The above document is available at:

<https://www.honeywellprocess.com/transmitter-configuration-tools-and-accessories/mc-toolkit>

## 3.2 MC Toolkit Assembly

### MCT404 assembly

Figure 3-1 shows the MCT404 assembly.



Figure 3-1 MCT404 assembly

Table 2 describes the components of the MCT404 assembly.

**Table 2 Components of MCT404 assembly**

<b>Item</b>	<b>Description</b>
<b>1</b>	Positive and negative test leads.
<b>2</b>	Connecting terminals for test leads.
<b>3</b>	Test leads to connect to the field device.
<b>4</b>	Functional keys which can be configured.
<b>5</b>	Navigational keys.
<b>6</b>	Button for powering on/powering off the MC Toolkit.
<b>7</b>	Pin charging plug with USB connector.
<b>8</b>	Reset buttons. For Soft Reset, press both the buttons simultaneously.

---

## 3.3 Safety instructions

### General safety instructions

Persons using the unit must observe the standard safety regulations and read the certificate to prevent incorrect operation or misuse of the unit.

### For MCT404

For general safety instructions while using MCT404, refer to the “Safety regulations – General safety instructions” section of “[300011CB02A01\\_instruction\\_manual\\_irocCi70-Ex\\_EN.pdf](#)” that is shipped with the MCT404 product

***The safety instructions from the above Safety Guide have been updated below as they are applicable to MCT404 product. The following additional safety regulations must also be observed:-***

- The unit must not be opened within the Ex-area.
- For battery information refer to [MCT404 battery replacement section 7.1](#)
- Avoid using the unit in aggressive acidic or alkaline solutions.
- Ensure that the MCT404-X\_ Ex unit is not taken in to Zone 0 areas.
- Ensure that the MCT404 - Y\_ Ex unit is not taken into Zone 1/0 or 21/20 areas.
- Ensure that the MCT404 - ZZ unit is not taken in to Ex-area.
- Electromagnetic waves, which can arise with the i.roc when using WLAN or Bluetooth functions, can cause disturbances and endanger your health! Since no definite statements can currently be made about the immunity from disturbances of heart pacemakers, we recommend users of pacemakers to avoid using transmitters generally.
- Do not transmit near persons with pacemakers!
- Permission to use electronic devices in airplanes is up to the respective airline.
- Avoid effects of elevated heat: Do not place the device near heat sources, such as radiators, air-conditioner air exit openings, stoves or other devices (including amplifiers) that radiate heat.
- Avoid effects of moisture.
- Do not put any objects into the product: Do not put objects into the housing or other product openings. These openings must not be obstructed, blocked or covered.
- Set-up: Never set up the product on a table, vehicle, stand or holder that is not stable. Follow the manufacturer’s instructions when setting up or installing the product, and use the accessories recommended by the manufacturer for installation.
- Adjust loudness: Reduce the volume before using earphones or other audio devices.

## 3.4 Battery and Power Supply

For battery care of MCT404, refer to [MCT404 battery replacement section 7.1](#)

For the Power supply information for MCT404, refer to “*300011CB02A01\_instruction\_manual\_irocCi70-Ex\_EN.pdf*” that is shipped with the MCT404 product

## 3.5 Start up, Shutting down the MC Toolkit

The section explains how to start the MC Toolkit.

### **Starting the MCT404**

Press the Power button on the MC Toolkit to start the MC Toolkit, and wait until the main PDA window appears displaying the **Start** icon.

### **Shutting down the MCT404**

Press the Power button on the MC Toolkit and hold it for few seconds to shutdown.

## 3.6 Application icons

Select on the **Start** icon. All the available shortcuts will be displayed under the **Start** Menu as shown in Figure 3-2.



**Figure 3-2 Start Menu**

The icons for the two applications MC Toolkit and FDC are available directly under the “**Start**” Menu. If any or all of these icons are not available under the Start Menu, select ‘**Programs**’, and locate the **MC Toolkit, FDC** icons.



### 3.7 Connecting to a device through MC Toolkit (MCT404)

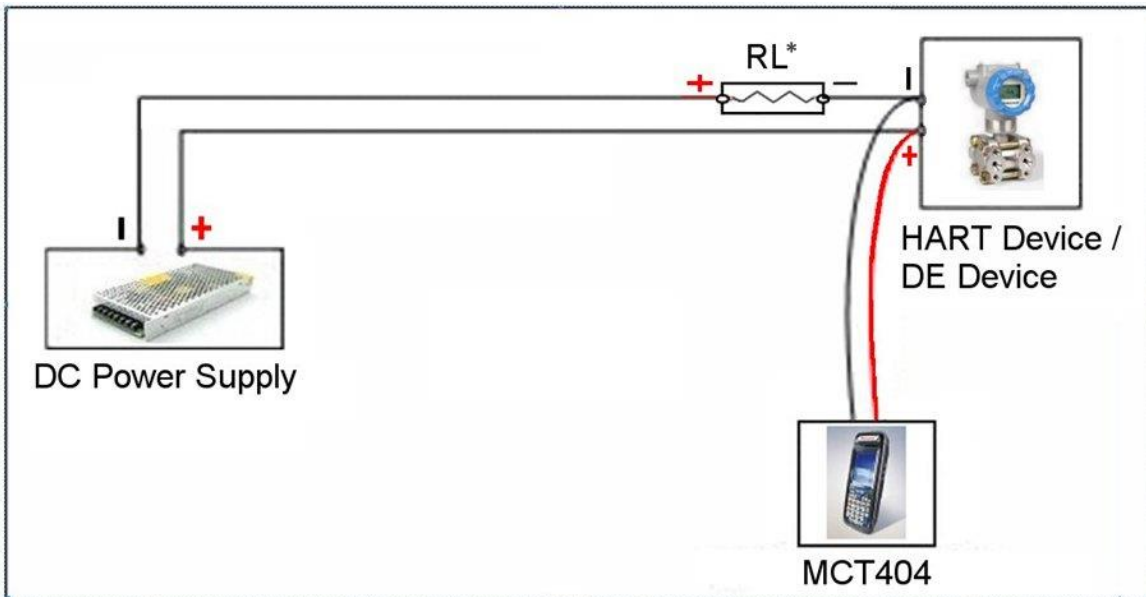
Figure 3-3 shows how a field device is connected through MCT404. Refer to the [MCT404 assembly](#) for more details.



**Figure 3-3 Connecting to a device through MCT404**

## Wiring diagrams

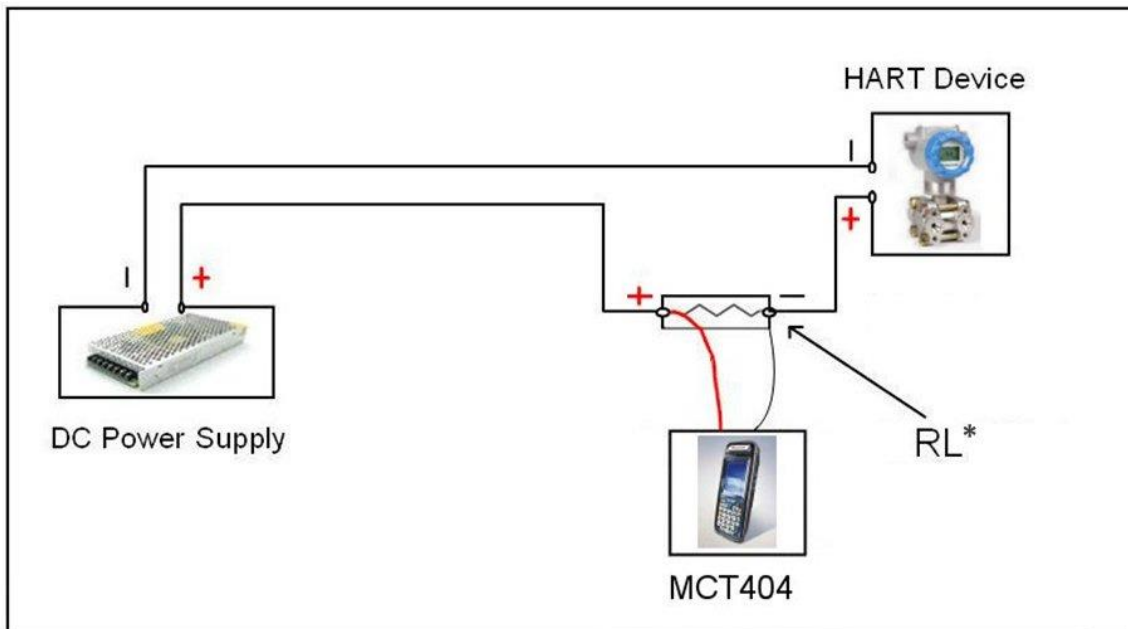
Figure 3-4 displays how to connect directly to the terminals of HART/DE device



**Figure 3-4 MCT404 terminal connections to HART/DE device**

\* Consult individual transmitter specification sheets for information on Loop Resistance vs Supply Voltage values.

Figure 3-5 displays connecting HART device



**Figure 3-5 MCT404 terminal connections to HART Device**

\* Consult individual transmitter specification sheets for information on Loop Resistance vs Supply Voltage values.

## 3.8 Connecting MC Toolkit to a PC

### Connecting MCT404

1. Connect the USB connection cable to a free USB port on the PC.
2. Insert the MC Toolkit into the docking station.
3. Follow the Active Sync/Mobile Device Center instructions appearing on the screen to establish the connection between the MC Toolkit and the PC.

## 3.9 Types of input methods


The MC Toolkit application allows you to provide inputs through various mechanisms supported through Windows Mobile platform, they are, Keyboard, Block Recognizer, Letter Recognizer, and Transcriber. On the other hand the FDC application supports the input through a custom keypad which supports numeric or alphanumeric keys depending upon the input context.

In the Keyboard method, you select a text field in display, and then selects a character at a time from a virtual keyboard. Using the keyboard involves familiar concepts that will enable quick and accurate entries.

In the other three methods, the stylus is used to write the desired input directly onto the screen, and each requires some adaptation of user skills. Of these, the Transcriber is probably the most efficient and easiest to use.

### Character input using keyboard

For character input using keyboard, perform the following steps.

1. Tap on the arrow  at the bottom right corner of the display and tap on a key on the **Keyboard**.
2. Use the stylus to provide a character at a time from the virtual keypad as shown in Figure 3-6. The familiar QWERTY keypad layout enables quick and accurate entries.

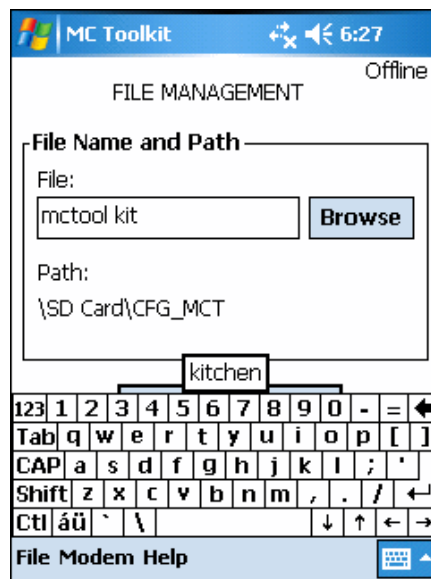

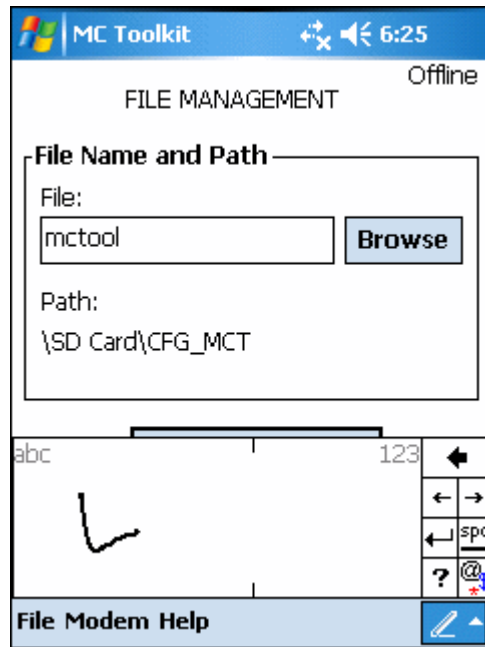


Figure 3-6 Virtual keypad

### Character input using *Block Recognizer*

For character input using block recognizer, perform the following steps.

1. Tap on the arrow  at the bottom right corner of the display and tap on **Block Recognizer**.
2. Use the stylus to provide a character input to the letter pad at the bottom of the screen. The character strokes are then converted to typed text on the screen as shown below in Figure 3-7.




**Figure 3-7 Block Recognizer**

**Note:** Tap on ? icon to view the help for using Block Recognizer, and tap on @\$ icon to view the table of symbols.

### Character input using Letter Recognizer

For character input using letter recognizer, perform the following steps.

1. Tap on the arrow  at the bottom right corner of the display and tap on **Letter Recognizer**.
2. Use the stylus to provide character inputs between the lines which appear at the bottom of the screen. The character input is recognized and displayed on the screen as shown in Figure 3-8.

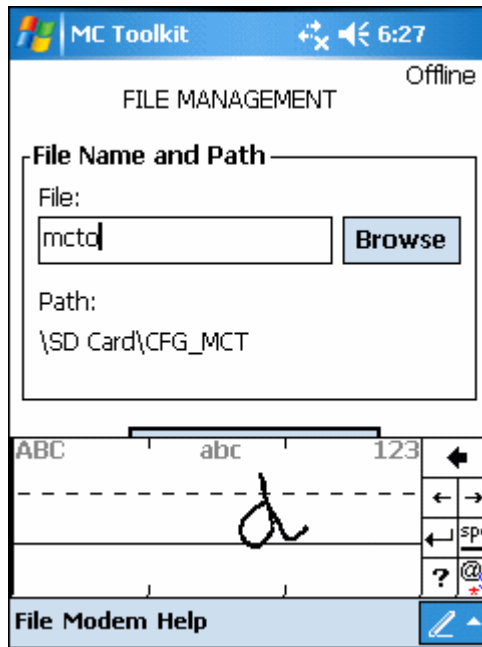

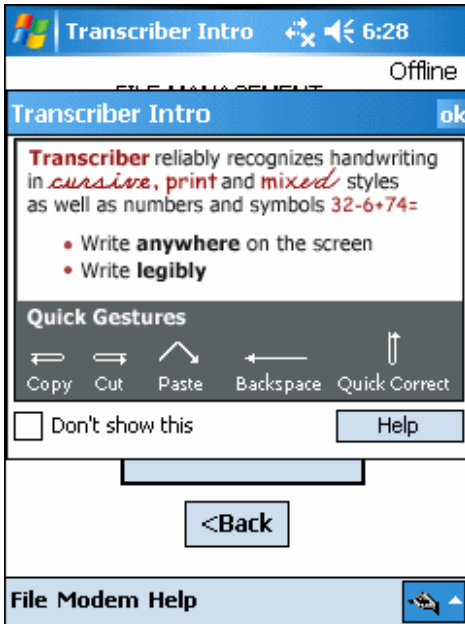


Figure 3-8 Letter recognizer

### Character input using Transcriber

For character input using transcriber, perform the following steps.

1. Tap on the arrow  at the bottom right corner of the display and tap on **Transcriber**.



2. Use the stylus to input the characters by writing them on the screen, in cursive, print or, mixed handwriting. The character input is recognized and displayed on the screen as shown in Figure 3-9.

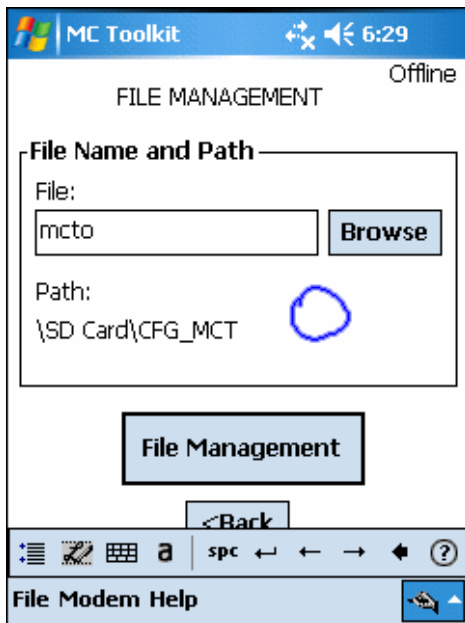


Figure 3-9 Freehand recognition

### Input dialog in FDC

Depending upon the context of the data, FDC smartly presents an alphanumeric or numeric keypad for data entry as shown in Figure 3-10.

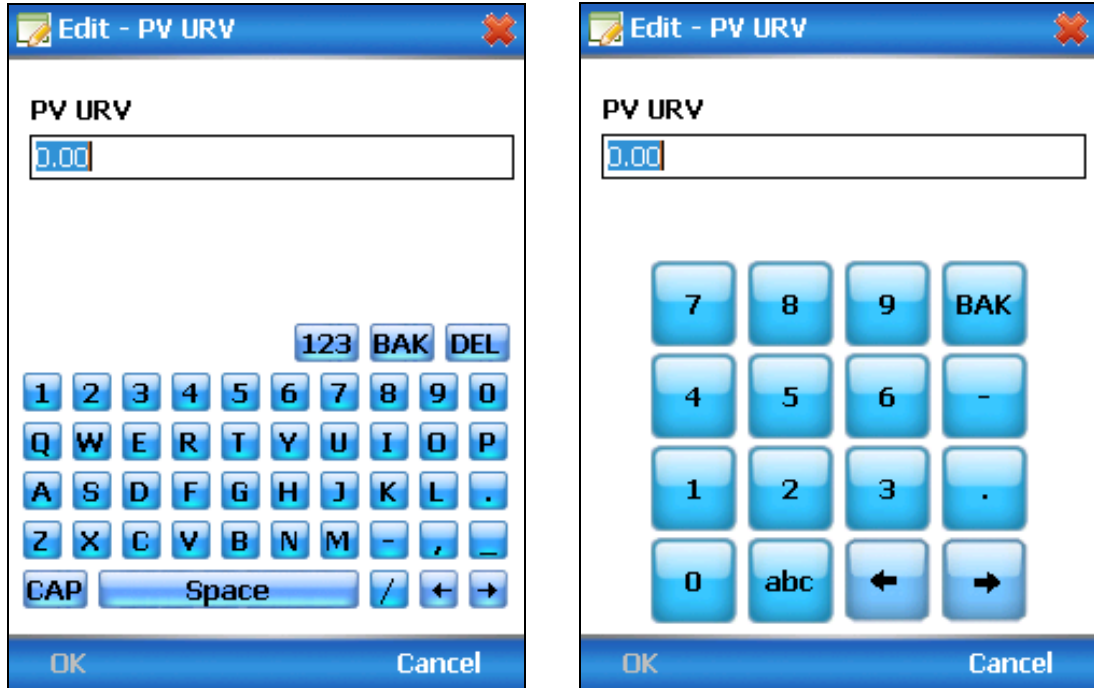


Figure 3-10 Alphanumeric keypads

## MCT404 Function Keys

MCT404 supports 2 versions of Keypads: Numeric and Alphanumeric. Numeric keypad has F1 through F10 function keys. Alphanumeric keypad has F1 through F8 function keys. Key assignments in FDC and MC Toolkit applications are shown in the Table 3 below:

**Table 3: MCT404 Function Keys**

Function key (Numeric)	Function key (AlphaNumeric)	FDC	MC Toolkit
F1	F1	Navigate Forward through Menus	NA
F2	F2	Navigate Forward through Menus	NA
F3	F3	NA	About MC Toolkit
F4	F4	NA	Exit MC Toolkit Application
F5	F5 (Shift+F1)	NA	Modem Diagnostics
F6 (Shift+F1)	F6 (Shift+F2)	Volume Up	Volume Up
F7 (Shift+F2)	F7 (Shift+F3)	Volume Down	Volume Down
F8 (Shift+F3)	F8 (Shift+F4)	NA	File/Options
F9 (Shift+F4)	Not Available	NA	Help Topics General (**)
F10 (Shift+F5)	Not Available	NA	Help Topics DE (**)

(\*\*) Available in Numeric keypad models only

NOTE: In the MC Toolkit application, select Help / About MC Toolkit to find the supported Function keys. In FDC Application, select the "Application Information" icon on the Home page (See Figure 4-2 and Table 5) to find the supported Function keys



## 4. Managing HART Devices using FDC Application Software

### 4.1 Starting FDC

To start FDC, perform the following steps.

1. Turn on the MC Toolkit.

**Note:** For information on turning on the MC Toolkit, refer to section 3.5\_Start up, Shutting down the MC Toolkit and 3.6 Application icons.

2. Select FDC from the Start menu. The FDC homepage appears.

### Generic layout of user interface of FDC

The FDC generic layout consists of title bar, workspace, and menu bar, which appear consistently on all screens, and the options may vary depending on the context and selection.

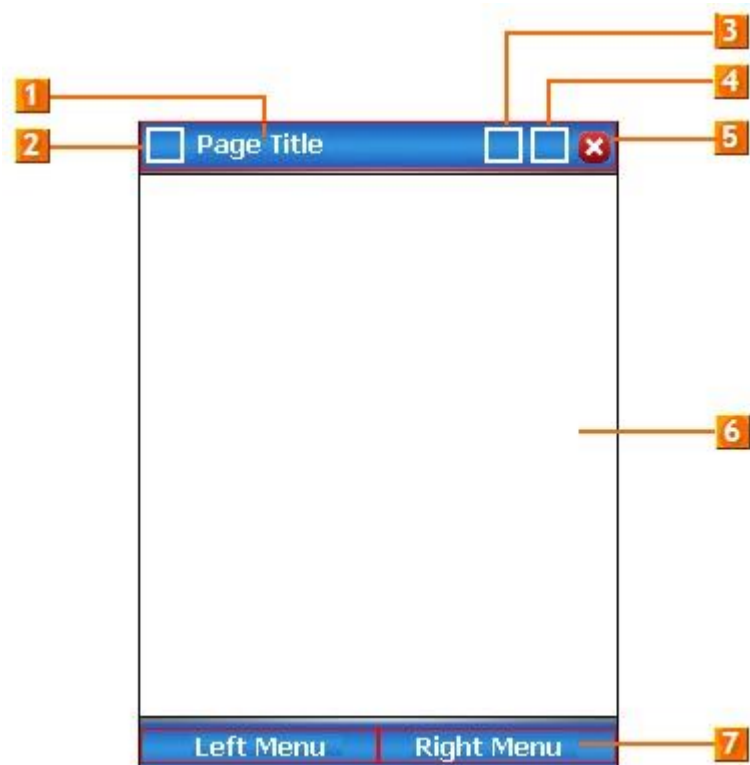


Figure 4-1 Generic layout of user interface

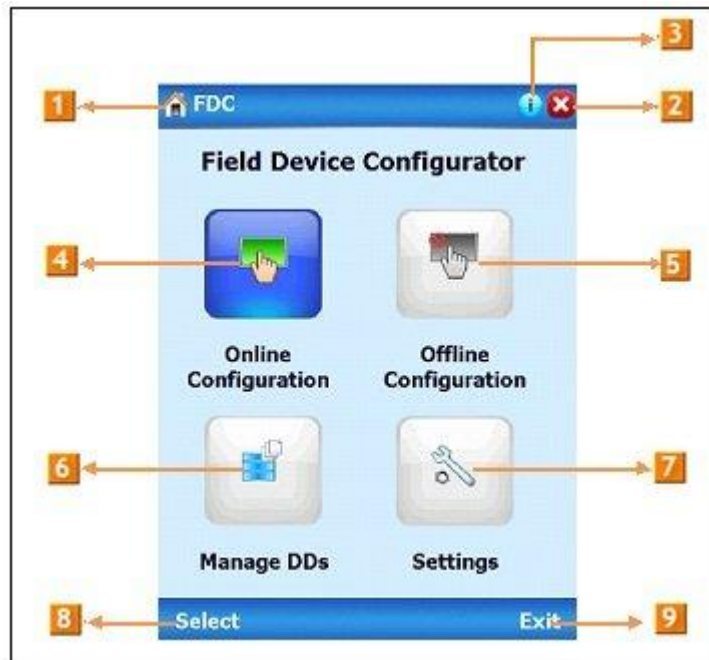
Table 4 describes the UI elements that appear on all FDC pages.

**Table 4 Generic UI elements**

Items	Description
<b>1</b>	Title bar – Displays the current page title.
<b>2</b>	Page icon – Displays current page icon
<b>3</b>	Icon 1
<b>4</b>	Icon 2
<b>5</b>	Exit button – Tap to quit the current page.
<b>6</b>	Workspace – Consists of various menu items for working with FDC.
<b>7</b>	Menu bar – Consists of options for navigation and selection.

## 4.2 Overview of FDC homepage

The FDC homepage consists of links for Online Configuration, Offline Configuration, Manage DDs, and Settings. Figure 4-2 shows the FDC homepage.



**Figure 4-2 FDC homepage**

Table 5 lists the items that appear on the FDC homepage and its descriptions.

**Table 5 FDC homepage elements**

Items	Description
1	Screen title.
2	Tap to quit FDC.
3	Tap to view the application information.
4	Tap to navigate to Online Configuration screen.
5	Tap to navigate to Offline configuration screen.
6	Tap to navigate to Manage DDs screen.
7	Tap to navigate to Settings screen.
8	Tap to select the highlighted menu option.
9	Tap to quit FDC.

**Note:** To select a particular option in FDC you can either select the option and then tap **Select** or you can directly double-tap the option.

For example, double-tap **Online Configuration** or tap **Online Configuration > Select**. The **Device Configuration** page appears.

## Settings

Use this feature to customize FDC. You can customize FDC for device detection, DD selection, and other application settings.

### **Device Identification**

Use the following options to configure FDC to identify a device.

- **COM Port:** It allows selection of COM port to which HART/DE is connected
- **Using Poll Address**
  - **Use poll address 0 only:** Use this to detect a device with the poll address as zero.
  - **Find first poll address and use:** Use this to detect a device with the first available poll address in the range of poll addresses that are available.
  - **Use selected poll address:** Use this to detect a device with a specific poll address in the range of zero to 63.
  - **Use From:** Use this to detect a device based on a range of poll addresses.
- **Using Device TAG:** Use this to detect a device with a known HART tag.
- **Using Device LONG TAG:** Use this to detect a device with a known HART long tag (applicable for devices with HART 6 or later Universal revisions).

**Note:** If you choose the option **Using Device TAG** or **Using Device LONG TAG**, FDC prompts you to enter a device tag/long tag name during device detection.

### **DD selection**

Use the following options to configure FDC to select DD files when a DD with matching device revision is not available.

- **Use DD file of previous device revision:** Use this option to automatically load a device with a DD file having device revision lower than that of the device.
- **Use generic DD file:** Use this option to automatically load the device with an appropriate generic DD file.
- **Always ask user:** Use this option to always prompt you with a choice for loading the device either with the previous device revision or with generic DD file.

**Always Use Generic:** Use this option to always load the device using generic DD files even if a DD file with matching device revision as the device is present.

**Note:** A generic DD file is a DD file that provides access and interface to the universal data and features of a HART device.

### **Other settings**

**Low storage notification:** Use this option to set a percentage value and to notify you with a warning message when the available storage card space is less than the percentage set.

**Application diagnostics:** Use this option to enable or disable the logging infrastructure for application diagnostics. With this option enabled, FDC creates necessary log files for troubleshooting and diagnostics. These files are stored in SD Card\FDC folder.

**Note:** You must not enable this option unless suggested by Honeywell TAC because this may impact the application performance.

### **Manage DDs**

Using this feature, you can manage the DD files installed with FDC. A DD file contains descriptive information about the functionality of a device. By default, a set of DD files are installed with FDC. However, if you do not have a DD for a given device, you can install it using the “Add DD” feature. Similarly, you can uninstall a DD file or a set of DD files using “Delete DD” feature. You can also directly copy the DD files in appropriate hierarchy using a card reader or “Active Sync/Mobile Device Center” mechanisms. In such a case, you should validate the library view using the “Refresh” feature.

### **Online configuration**

Using online configuration, you can configure, calibrate, monitor and diagnose a HART device which is connected to MC Toolkit. FDC provides the features to perform these functions through the various constructs offered through the DD file of the device. Besides there are certain other features available under this link for you to conveniently work with a HART device with live communication. After making changes to the device you can also save a snapshot of the device data as history to later transfer it to FDM for record and audit purposes.

### **Offline configuration**

Offline configuration refers to configuring a device offline (without physically connecting to the device) using a template and then downloading the configuration to the device. Presently, FDC application software does not support creating offline configuration. However, it supports importing of offline configuration from FDM (R310 and above).

## 4.3 Customizing the settings

### Modifying device identification settings

Using the Device Identification settings, you can choose how to detect a device. Devices can be detected using poll address or device tag name. By default, devices are detected using poll address zero. However, you can modify these settings based on how you want to detect devices.

To modify the device detection settings, perform the following steps.

**Note:** Before modifying the settings, see [Settings](#) for more information.

1. On the FDC homepage, tap **Settings > Select**.  
The **Settings** dialog box appears.
2. Tap **Device Identification** tab.
3. If you want to detect a device using the device specific tag name, select **Using Device Tag** checkbox (for HART 5 or later versions) or **Using Device Long Tag** checkbox (for HART 6 or later versions).
4. If you want to detect a device using poll address, select **Using Poll Address** check box.
  - To detect a device using poll address zero, tap **Using poll address 0 only**.
  - To detect a device using first poll address, tap **Find first poll address and use**. With this setting, FDC will detect the first device which responds on any poll address during a scan from 0 to 63.
  - To detect a device using selected poll address, tap **Use selected poll address** and choose the appropriate poll address using the up and down arrow keys.  
For example, if you want to detect a device with poll address 20, press and hold the up or down arrow key until the poll address 20 appears.
  - To detect a device using a range of poll addresses, tap **Use From** to choose the device between the ranges of poll address you want to detect.  
For example, if you want to detect a device within the range of poll address 20 and 25, press and hold the up or down arrows keys to specify the range of poll address.

### Modifying DD selection settings

Using the DD selection settings, you can choose how to select a DD file for a device, when a DD with matching device revision is not present. By default, the option **Always ask user** is selected. To modify the DD selection settings, perform the following steps.

**Note:** Before modifying the DD selection settings, see [Settings](#) for more information.

1. On the FDC homepage, tap **Settings > Select**.  
The **Settings** dialog box appears.
2. Tap **DD Selection** tab.
3. If the DD file with the current device revision is missing for a device, select one of the following:
  - a) Use DD file of previous device revision
  - b) Use generic DD file
  - c) Always ask user.

4. If you want to load devices with a generic DD files even if a DD matching the device revision is available, select the checkbox under the **Always Use Generic** option.

#### **Modifying other default settings**

Using the “Others” tab under settings, you can set the following:

- Threshold percentage for notifying a low storage space warning. By default, the notification for percentage of available storage card space is set as 5%. Note that you cannot reduce the percentage beyond 50%.
- Enable or disable logging option for generating application diagnostic log files.

To modify the settings for low storage warning, perform the following steps.

1. On the FDC homepage, tap **Settings > Select**  
The **Settings** dialog box appears.
2. Tap **Others** tab.
3. Select **Low Storage Space Warning** checkbox.
4. Press and hold the up or down arrow keys to set the notification for percentage of available storage card space, which is available.

For example, if you want to set the percentage for notifying a low storage card space to 20%, press and hold the up or down arrow keys until the required percentage appears.

To modify the settings for saving log files, perform the following steps.

1. On the FDC homepage, tap **Settings > Select**  
The **Settings** dialog box appears.
2. Tap **Others** tab.
3. Select **Enable** or **Disable** under the **Application Diagnostics** option.

Once you are done with the desired changes in Settings, tap “Save” on the menu bar. The modified settings are then updated successfully in the application. Tap “Return” to return to the FDC home page.

## 4.4 Managing DD files

### Overview

Using Manage DDs, you can view, add, or delete DD files for devices. A list of already available DD files is maintained in the DD Library. FDC lists the installed DD files in a hierarchy as below:

Manufacturer  
Device Type  
DevRev xx, DDRev yy  
DevRev pp, DDRev qq

### Add a DD file

To add a DD file for a device, perform the following steps.

1. From the FDC homepage, tap Manage DDs > Select.

The **Manage DDs** dialog box appears.

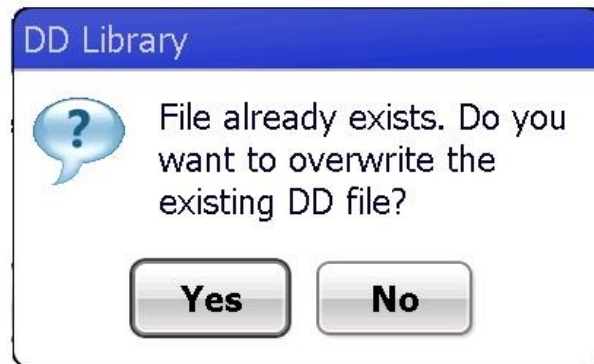
2. Tap **Options** > **Add DD**.

Or



The **ADD DD files** dialog box appears.

3. Browse to the location in which the DD file (**.fm8**) is located and tap **OK**.
4. If the DD file already exists, then the following message appears.



5. Tap **Yes** to overwrite the existing DD files.
6. If the DD file is added successfully, a success message appears.

### **Delete a DD file**

Using this option, you can delete a particular version of a DD file. To delete a DD file for a device, perform the following steps.

1. From the FDC homepage, tap **Manage DDs > Select**.

The **Manage DDs** dialog box appears.

2. You can choose to delete DD(s) in one of the following ways:
  - a) By device manufacturer – Select a device manufacturer to delete all device types and DDs associated with the manufacturer’s devices.
  - b) By device type – Select a device type to delete all DDs associated with the device.
  - c) By device revision and DD revision – Select the specific entry of device revision, DD revision to delete the specific DD
3. Tap **Options > Delete DD**.

Or



A confirmation message appears.

4. Tap **Yes**.

If the DD file is deleted successfully, a success message appears.

5. Tap **OK** to return to **DD Library** page.



### **Validating a manually edited library**

Besides using the Add/Delete DD features, advanced users may also manipulate a DD library by directly editing the contents of the FDC\Library folder. DD files can also be transferred directly to this location by accessing the SD Card on MCT404 through a card reader and/or by connecting the MCT404 to a PC. In such cases, you must perform the following steps to validate a DD Library, thus edited manually:

1. From the **FDC homepage**, tap **Manage DDs > Select**

The **Manage DDs** dialog box appears

2. Tap **Options**.
3. Tap **Refresh Library**.

Or



A confirmation message appears.

4. Tap **Yes**. The DD library is now validated and refreshed.

## **4.5 Overview of device configuration**

Device configuration is the process of setting the variables of a device to desired values. Typically, the configuration process is equated with the act of writing values to a device, but procedurally it involves the following:

- Identifying a device
- Reading/observing device variable values
- Editing variables
- Sending edited variables to the device
- Saving the variable values
- Saving and downloading the device configuration.

When performing the above stated procedures and the device being available on an active communication link, the process is generally termed as Online Configuration. On the other hand, you may prepare a set of values for device variables even when the physical device is not present and then you send these values down to the device once the same is available on the communication link. This process is generally termed as Offline Configuration.

## 4.6 Online configuration

Online Configuration option provides you a set of functions with which you can perform various operations on a device with active communication link. These operations primarily include configuration, calibration, monitoring, and diagnostics of a HART device. Typically, these operations could be realized through various constructs exposed by the DD file of the device. In addition, FDC also provides some additional application functions for you to perform these functions more conveniently.

### *Detecting and loading a device*

When you tap on **Online Configuration**, the device detection and loading process automatically gets started. Depending upon the Device Detection and DD Selection settings you may have chosen, you may be prompted for certain inputs as described in the [Settings](#) section.

### Overview of Device Homepage

Once the device is detected and loaded successfully, you can view the device homepage for the identified device. The workspace area on the device homepage consists of 4 tabs on the left hand side. Selecting a tab displays functions/information associated with that tab on the right hand side.

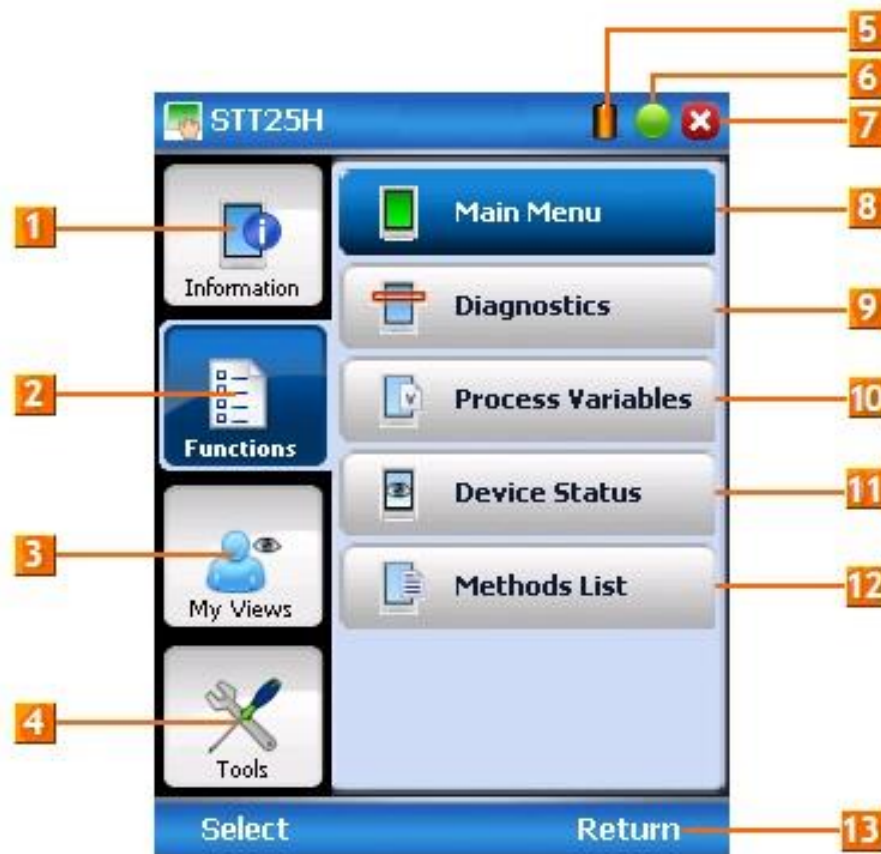


Figure 4-3 Device homepage

Table 6 lists the entry points and its descriptions.




**Table 6 Device homepage elements**

Items	Description
<b>1</b>	Tap <b>Information</b> tab to view the device identity related information.
<b>2</b>	Tap <b>Functions</b> tab to choose from various options to configure, calibrate, monitor and diagnose the device
<b>3</b>	Tap <b>My Views</b> tab to create and use your own custom views.
<b>4</b>	Tap <b>Tools</b> tab to use FDC specific tools applicable to the device.
<b>5</b>	Indicates modem battery status.
<b>6</b>	Indicates device health status, which may need attention
<b>7</b>	Tap to close the device home page
<b>8, 9, 10</b>	Device specific “entry points”. The number and labels on these entry points may vary from device to device as defined in the DD file.
<b>11</b>	Select this option to view the detailed status of the device with respect to the Communication, Device Status and device specific diagnostic details.
<b>12</b>	Tap <b>Methods List</b> to view and execute methods.
<b>13</b>	Tap to close the device home page.

**Note:** The entry points, **Device Status** and **Methods List** appear for all devices.

Table 7 lists the device health status and their indications.

**Table 7 Device health status**

Device health icons	Indications
	Indicates there's no health or status indicators reported by the device
	Indicates that the device is potentially reporting a status which needs attention and further investigation. It is advised that you use Device Status under Functions tab to further investigate the details.
	Indicates that the device has lost communication with MC Toolkit

## Tabs on the Device Home page

The following are the options that are available on the device homepage

- **Information tab:** Use this option to view the device identity related information. You can view the manufacturer name, device type, device revision, DD revision, and universal revision of the HART device.
- **Functions tab:** This tab provides various options which you may use for navigating through the device specific user interface and some standard features offered by FDC across all devices. For the sake of explanations, the right side options under this tab shall be referred as “Entry points” throughout the rest of the document.
- **My Views tab:** Quite often, you may be interested only in a set of variables of a device. But navigating through the menu tree of a device may not be helpful because of time and further all variables that you want may not be in the same location. Using this unique feature of FDC, you can now choose what you want to view in a device in your own views. FDC allows you to create two such views per device revision of a specific device type. You can always modify them as per your needs.
- **Tools tab:** This tab is a placeholder for FDC specific tools for providing certain functionality. Currently the only option it provides is called as Save History. Using this option you can save the snapshot of the device variables. This snapshot is saved in a format which can be later imported as a history record in FDM.

### *Using FDC for various device operations*

Typical operations with a smart field device involve configuration, calibration, monitoring, and diagnostics. Any combination of these operations may be required in different phases of a device life cycle in a plant, such as Commissioning, Operations, and Maintenance. FDC enables you to achieve these operations with a HART device via the various interfaces/constructs exposed through the DD file of the device. Configuration involves setting variables to desired values. Calibration is the process of verifying certain aspects of device measurements against set standards and then tuning them to meet the desired limits. Both these operations are enabled through editing (and writing) variables or executing well defined methods. Monitoring is an operation which involves observing values of a set of variables. This could be achieved simply by reading the variable values in different menu groups, or through visual constructs such as Graphs, Charts, and so on.

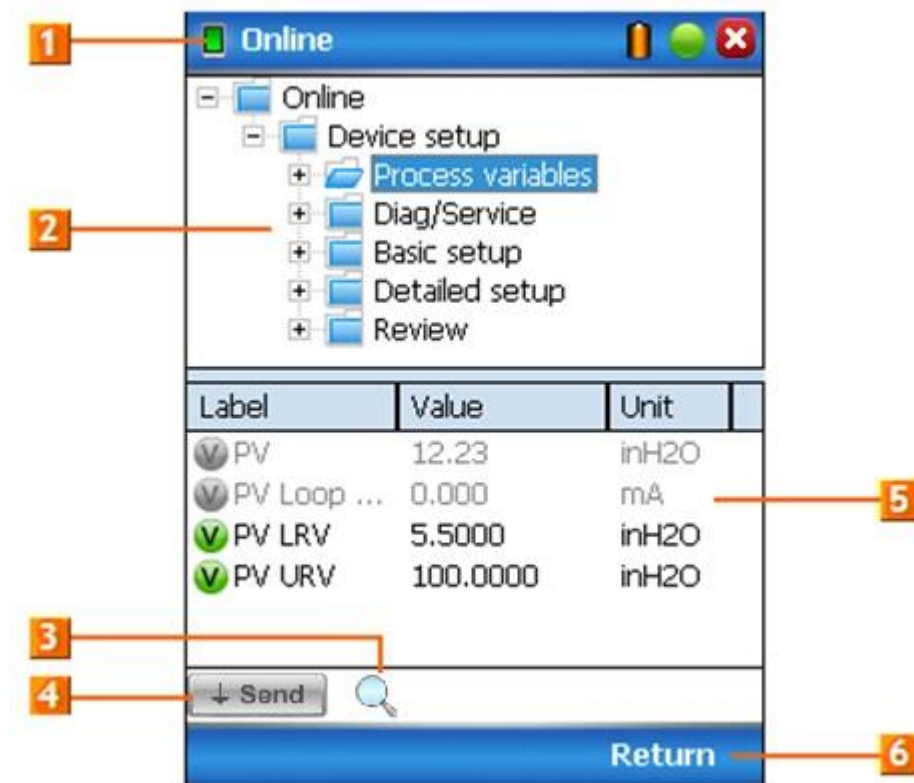
Diagnosing a device may involve any combination of reading/writing or observing a set of variables through various constructs. Quite often diagnostics may involve executing a method to perform a well-defined procedure to see the behavior. All HART devices have special variables which indicate the diagnostic status of a device as well. In common terms, the diagnostic status of a device is often termed as device health as well. Besides these an interface of a device may also contain certain other constructs such as Images, Grids, and so on. These are primarily meant for aiding the above-mentioned operations.

The “Functions” tab under the device home page provides the entry points for navigating through the device specific user interface to perform the above mentioned operations. A device may define up to four entry points in the DD file which are presented as is. All devices shall have at least one entry point and generally it is called as “Online”. Besides the device specific entry points FDC provides custom entry points for navigational aids to specific type of information/features. One such entry point is called as Device Status used for reviewing device health and the other one is called as Methods List, used to navigate to all the methods available in a device.

All the device specific entry points present the device interface, as explained using the Online entry point as an example. All the other device specific entry points have the similar interface except for the fact that the variables and other DD constructs provided under each may vary as indicated by the title of each entry point.

For the sake of explanation, the pages that appear on navigating through the device specific entry points are called as “Device Configuration” pages in this document. However it must be noted that this does not prohibit you from performing other device operations as explained above.

**Online Entry Point:** When you tap on to open the online tab, the device configuration screen appears as shown in the following figure.



**Figure 4-4 Device configuration screen**

Table 8 lists the items and its descriptions that appear in the device configuration screen.

**Table 8 Device configuration screen elements**










Items	Descriptions
1	Device configuration page icon and title.
2	Top pane which consists of set of menu options in hierarchy as defined in the DD file.
3	Tap to search items in the current entry point for the device.
4	Tap to review and send edited variables to the device. This becomes enabled only if at least one variable has been edited.
5	Bottom pane which consists of items corresponding to the selected menu.
6	Tap to return to Device homepage

A **Device Configuration** page is split horizontally into an upper and lower pane. The top pane displays the set of hierarchically organized groups called menus and the bottom pane displays the set of corresponding items under each menu. The bottom pane has three columns: Label, Value, and Unit. FDC also displays an icon against each item to visually identify different types of items. The Value and Unit

columns apply only to the items of type “Variables”. The items which are read only are displayed in Grey font, whereas others are displayed in Black font.

Table 9 lists the icons that appear in the Device Configuration screen.

**Table 9 Device configuration screen icons**

Icons	Descriptions
	Indicates a menu or submenu in the navigation tree.
	Indicates a currently selected menu or submenu in the navigation tree.
	Indicates a Method item.
	Indicates a Variable item.
	Indicates an Edit Display item.
	Indicates a Grid item.
	Indicates a Chart item.
	Indicates a Graph item.
	Indicates an Image item.

When you navigate to a specific menu in the top pane, FDC displays the items under that menu in the bottom pane. If the some of the items under the menu are variables (or parameters) then FDC also fetches their corresponding values from the device and updates them. Some of these variables are dynamic in nature which means their value changes without any input from the user. In such cases, FDC synchronizes and refreshes the values on periodic basis when such dynamic variables are on display.

## Viewing different type of variables

The variables when present under a menu are typically displayed with their label, value and unit. Note that for some variables, the unit may not be applicable. Some variables just display a hexadecimal value against their labels. When you select such a variable, “View” option gets enabled on the menu bar. Tap View to see the details of the selected variable.

### Editing device variables

To edit the variables, perform the following steps.

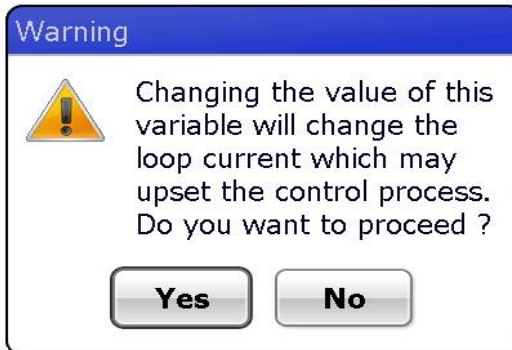
**Note:** Consider the following scenario as an example for an entry point. The entry points vary from device to device depending on the DD files.

1. On the **Device Home** page, tap **Functions** tab.
2. Tap **Online > Select**.
3. The **Device Configuration** page appears which displays the top and bottom panes.
4. Navigate to the desired menu. The bottom pane will display items under that menu.
5. Select an editable variable from the list.

**Note:** An editable variable can be differentiated from a read only variable, the read only variable is displayed in Grey text, whereas an editable variable is shown in Black text.

6. Tap Edit.

**Note:** If the variable has been defined as a Loop Warning Variable then following dialog appears:



7. Press **Yes** to proceed.


Further, if there are Pre-Edit Actions defined in the DD file for this variable, method dialog executing those methods appear. Respond to the steps in those methods to proceed to the edit dialog box.

8. The Edit dialog box appears with appropriate key pad as described in [Input dialog in FDC](#) section.
9. Modify the value using the keypad and tap **OK**.


**Note:** If there are Post-Edit Actions defined in the DD file for this variable, method dialog executing those methods appear. Respond to the steps in those methods to proceed to finish the edit process.

10. Once successfully edited the variable value field turns yellow to indicate that the value has been modified, but not sent to the device.

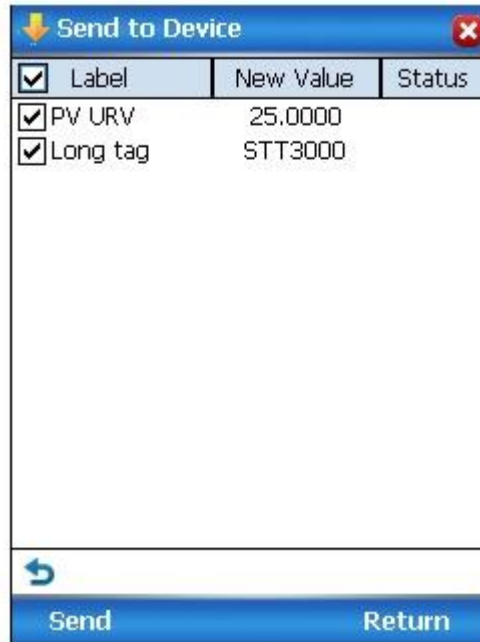
### Updating the device with edited variables

Editing the variables does not automatically send them to the device. You must explicitly perform the action of sending the values to the device to update it. Once you have edited one or more variables as explained above, the  icon at the bottom left corner of the page becomes enabled.

To update the device with edited variables, perform the following steps.

1. Tap  to send the edited variables values to the device.

The **Send to Device** page appears.




This page allows you to review the values you have edited and provides you a choice to either send the values to the device or even canceling your changes. To cancel your changes, simply select a required variable and tap reset, this action will restore the value of that variable(s) to the previous value.


2. Select the variable(s) whose value you want to send to the device.
3. Tap **Send** and the send process starts.
4. Subsequently, the status of the send process is updated against each variable.





If the variables are updated successfully to the device, status appears as **SUCCESS** in green color; and if failed, status appears as **FAILED** in red color.

5. Tap  to close the current page and to return to the previous page.


**Note:** Use  to reset the selected variable's values. Double tap on FAILED status to view the reason.

## Searching for an item


Often it is very tedious and time consuming to navigate to a specific item through a deeply nested menu structure. FDC allows you to search for an item in a particular entry point.

Using Search option, you can search for a device variable which is specific to the entry point, perform the following steps.

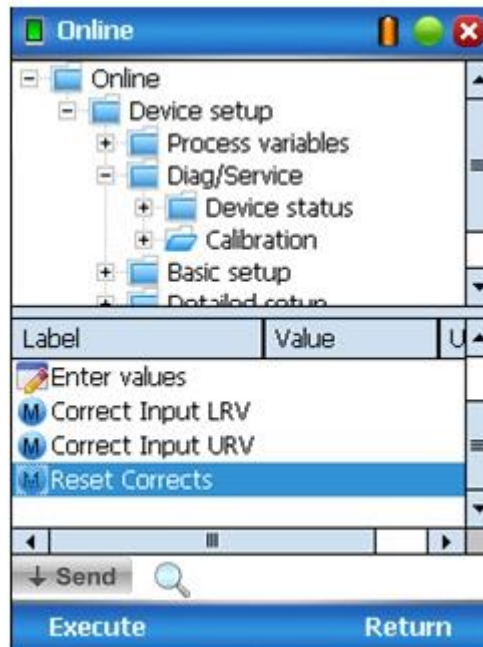
1. Under the **Functions** tab, choose **Online**.

2. Tap  icon on the bottom left part of the page.

The **Item Search** dialog box appears.

3. Under **All or part of the item label**, tap .
4. Enter all or part of the item label you want to search using the keypad.
5. Tap **OK**.
6. You can refine your search by selecting the type of item you want to search using **Search In** list.
7. Tap **Search**.
8. Under **Results**, select any of the results.
9. Tap **View**.

The searched item is highlighted in an expanded the tree view of menus in the top pane and the corresponding items in the bottom pane.



**Note:** Searched item is not shown if it is invalid in the device.

## Device Health Indicator and Details

Using the standard features of the HART communication protocol FDC provides an indicator of the device's health through a LED indicator on the title bar of each page. Quite often the details of such health indicators are available through different variables under different menus. FDC however provides an entry point on the functions tab to view the details of the device health indicators.

The Device Status entry point under the functions tab provides the details of device as under:

- **Device status:** Indicates the current status of the device with respect to different standard parameters such as process value, analog output, device malfunction and power reset etc. This also indicates if the device has more detailed status information available that may need attention.
- **Communication status:** Indicates the details of communication errors that might have occurred with communication to the device.
- **Extended Device Status:** Each HART device has a set of variables which can indicate an extended status for the device and its health. The numbers, labels and descriptions of such variables varies from device to device. FDC simply presents such variables to you as defined in the DD file. So if the Device Status has an indication that there's more status available for the device, these are the variables you should investigate for further details.

Perform the following steps to view the details of device health.

**Note:** For example, consider the following scenario.

1. On the **Device Home** page, tap **Functions** tab.
2. Under the **Functions** tab, choose **Device Status**.  
The **Device Status** page appears.
3. From the drop down list select any of the variables to view the details.
4. Tap **Return** to close the Device Status page and return to the Device Home page.

## Graphical items in a device interface

Devices using the Electronic Device Description Language (EDDL) constructs often enable you to view the device data as graphical/visual representation. These constructs are described in subsequent sections.

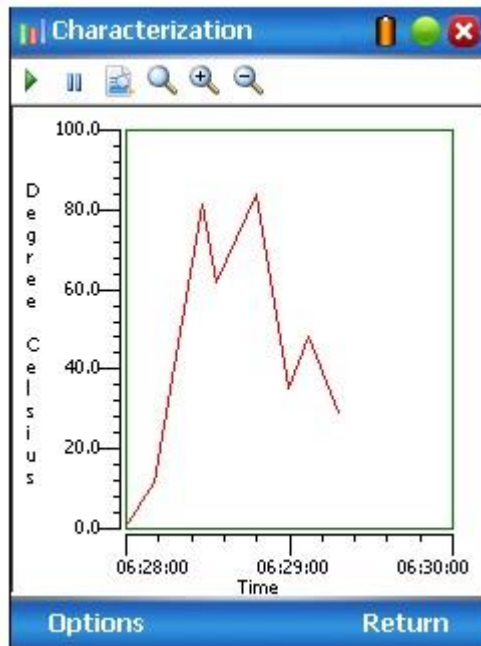
### Graphs

A graph is a visual representation of the device data plotted with reference to a set of axes. A graph has a common x-axis for all the data plotted. Each graph has one or more static curves obtained by joining the plotted pair of data points. Such curves are called as Waveforms. A set of waveforms may share a common Y axis. Based on the DD file, different colors for the waveform and axes are displayed. In addition, you can edit the waveforms and view the legends.

To view a graph, perform the following steps.

1. On the **Device Homepage**, tap on **Functions** tab.
2. Tap on **Online > Select**.
3. The **Device Configuration** screen appears which displays the top and bottom panes.
4. Navigate to the desired menu. The bottom pane will display items under that menu Select any graph from the list of available graphs which appear on the bottom pane.
5. Tap on **View**.

The graph screen appears.



6. Tap **Options** > **Select Waveform**.

The **Select Waveform** dialog box appears.

7. Select the required waveform and tap **OK** to view the graph of the selected waveform.
8. Tap **Options** > **View Legends**.

The **View Legends** dialog box appears with the legends.

9. Tap **Close** to close the **View Legends** dialog box.

10. Tap **Options** > **Edit Waveform**.

The **Edit Waveform** dialog box appears. This lists the x, y pairs for the waveform. The non-editable values are shown in grey.

11. Select the required value and tap **Edit**.

The **Edit Variable** dialog box appears.

12. Edit the value and tap **OK** to return to **Edit Waveform** dialog box.

**Note:** The edited value is highlighted in yellow color.

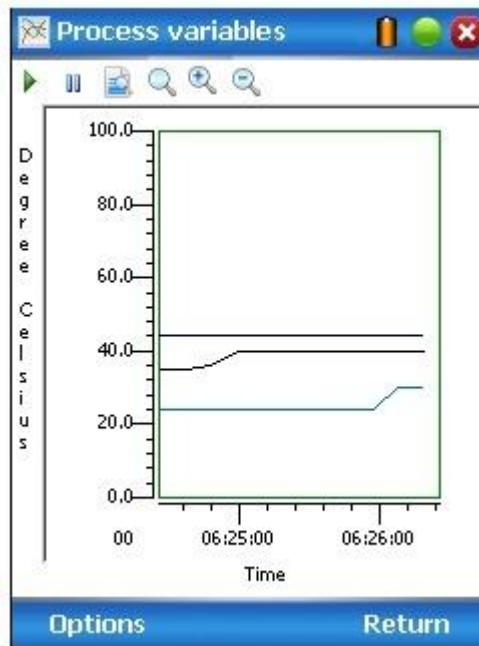
13. Tap **Return** to return to the graph page. The waveform is now updated with the edited value.
14. Tap **Return** to close the graph page and return to the menu navigation view.

### Charts

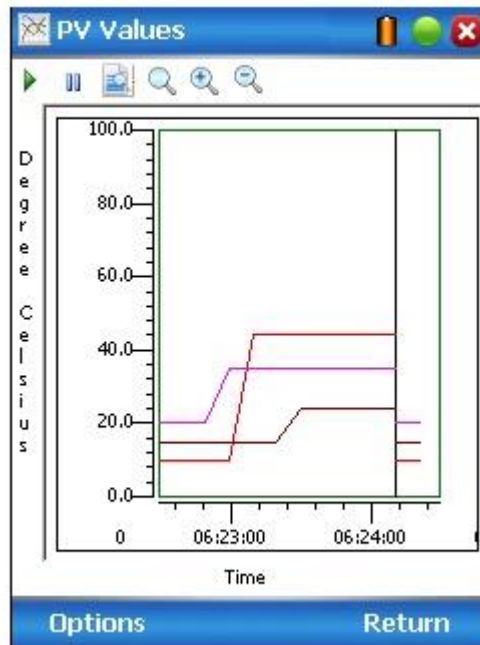
A chart is a graphical representation of the device data as it changes over time. The x-axis in a chart is always time. A chart may display one or more trends which are collectively called as a Source. Further, a chart may have more than one source which you may select to view. The colors, labels, and axes of charts may vary from device to device as defined in the DD file. The rate at which the chart is refreshed is governed by the DD file. The default refresh rate is 3 seconds.

The following are the types of charts.

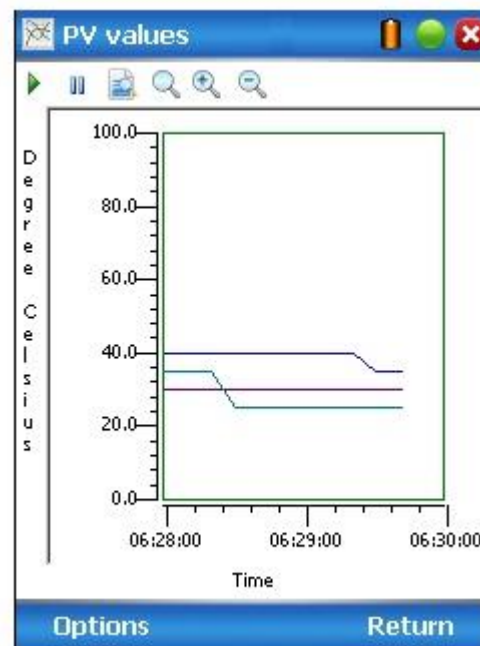
- **Strip:** In a Strip chart data scrolls from right to left. New data is updated at the right end of the chart with the historical data shifted to the left. Older historical data scrolls off to the left end of the chart.



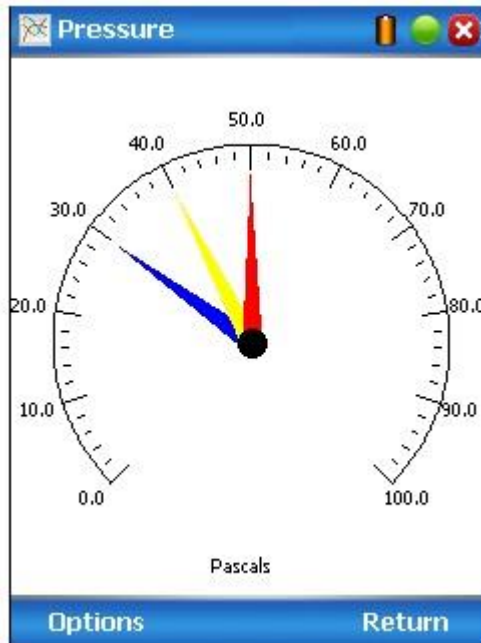
- Sweep:** A Sweep chart updates from left to right overwriting the oldest displayed historical data in the process. A vertical line separates the old data from the new and scrolls as the new data displays. When the plot reaches the right most end of the chart, the data begins plotting again from the left end of the chart.



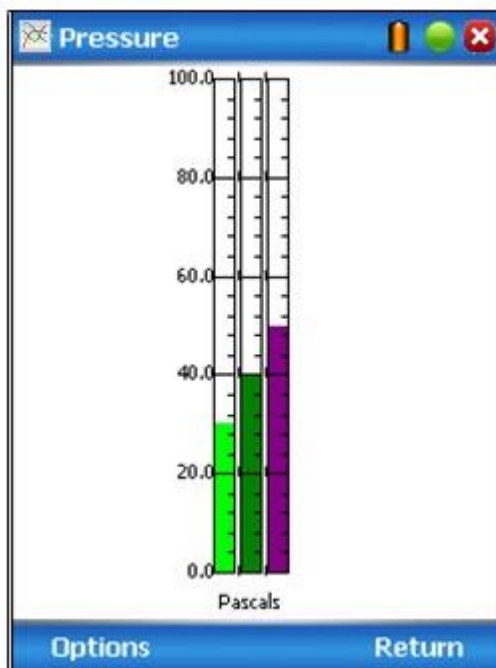
**Scope:** A Scope chart updates from left to right. When the plot reaches the right most end of the chart, the display is erased and the data begins plotting again from the left end of the chart.



- **Gauge:** A gauge chart formats the device data into a view similar to circular, dial-type analog meter. The indicator is a pointer that rotates as the current value varies with time.



- **Bar Charts:** A bar chart displays the device data in bars varying with time. A bar displays values from bottom to top with its origin (minimum value) at the bottom of the chart. Alternately, a bar may also display values horizontally from left to right with its origin (minimum value) at the left of the chart.



To view a chart, perform the following steps.







1. On the **Device Home** page, tap **Functions** tab.
2. Tap **Online > Select**.
3. The **Device Configuration** page appears which displays the top and bottom panes.
4. Navigate to the desired menu. The bottom pane will display items under that menu. Select any chart from the list of available charts which appear on the bottom pane.
5. Tap **View**.

The chart page appears.

6. Tap **Options > Select Source**.
7. The **Select Source** dialog box appears.
8. Select the required source and tap **OK** to view the chart of the selected source.
9. Tap **Options > View Legends**.
10. The **View Legends** dialog box appears with the legends.
11. Tap **Close** to close the **View Legends** dialog box.
12. Tap **Return** to close the chart page and return to the menu navigation view.

**Note:** The following options are available on the tool bar of the graph/chart page.

**Table 10 Tool bar on graph/chart page**

Options	Descriptions
	Tap to zoom out.
	Tap to zoom in.
	Tap to change from pan mode to zoom mode.
	Tap to pan.
	Tap to pause trending.
	Tap to resume the normal mode



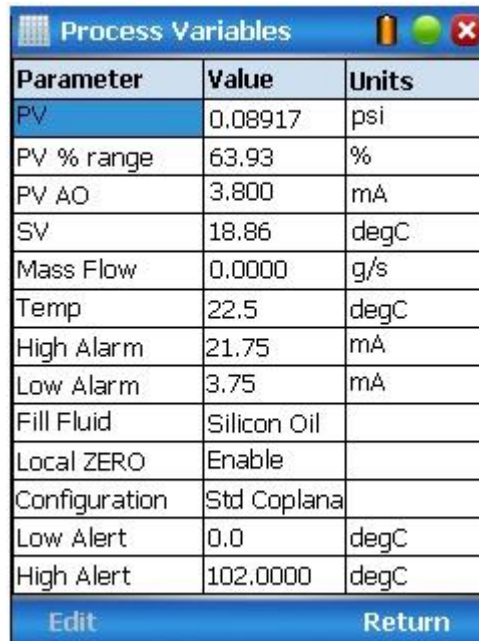
### Grids

A grid is a structure to display related device information in tabular form. The data may be organized with either the column headers or with the row headers.

To view a grid, perform the following steps.

1. On the **Device Home** page, tap **Functions** tab.
2. Tap **Online > Select**.
3. The **Device Configuration** page appears which displays the top and bottom panes.
4. Navigate to the desired menu. The bottom pane will display items under that menu. Select any grid from the list of available grids which appear on the bottom pane.
5. Tap **View**.

The grid page appears.



Parameter	Value	Units
PV	0.08917	psi
PV % range	63.93	%
PV AO	3.800	mA
SV	18.86	degC
Mass Flow	0.0000	g/s
Temp	22.5	degC
High Alarm	21.75	mA
Low Alarm	3.75	mA
Fill Fluid	Silicon Oil	
Local ZERO	Enable	
Configuration	Std Coplana	
Low Alert	0.0	degC
High Alert	102.0000	degC

At the bottom of the grid, there are two buttons: **Edit** and **Return**.

6. Select a value and tap **Edit**.

The **Edit** dialog box appears.

**Note:** The **Edit** option is enabled only if the value is editable.

7. Edit the value and tap **OK** to return to grid page.

**Note:** The edited variable is highlighted in yellow color.

8. Tap **Return** to close the grid page and return to the menu navigation view

### **Images**

An image is a picture of an object related to the device as defined by the DD file. An image may display anything from company information/logo to device image and drawings, and so on.

To view an image, perform the following steps.

1. On the **Device Home** page, tap **Functions** tab.
2. Tap **Online > Select**.
3. The **Device Configuration** page appears which displays the top and bottom panes.
4. Navigate to the desired menu. The bottom pane will display items under that menu. Select any image from the list of available images which appear on the bottom pane.
5. Tap **View**.

The image page appears.



7. Tap **Return** to close the image page and return to the menu navigation view.

## Executing methods on a device

To execute methods on devices, perform the following steps.

**Note:** For example, consider the following scenario to execute Loop test.

1. On the **Device Home** page, tap **Functions** tab.
2. Tap **Online > Select**.
3. The **Device Configuration** page appears which displays the top and bottom panes.
4. Navigate to the desired menu. The bottom pane will display items under that menu.
5. Select a method from the list. For example, **Loop Test**.
6. Tap **Execute**.

A warning message appears displaying a message that loop must be removed from the automatic control.

7. Tap **OK**.
8. The **Loop Test** dialog box appears displaying the information to choose analog output level.
9. Choose the analog output level and tap **OK**.

**Note:** To cancel the method execution, tap **Abort**.

10. A message appears displaying the information that the output value of the device is fixed.
11. Tap **OK**.
12. The **Loop Test** dialog box appears displaying information to choose analog output level.
13. In the Choose analog output level combo box, tap to select **End**.
14. Tap **OK**.

The method is executed successfully.

## Saving device history

FDC provides you a feature wherein you can save the device configuration snapshot as history. This history record may then be transferred to a central asset management database such as FDM.

Using this feature you can save the device configuration snapshot as device history of a connected device at any given time in a predefined location. The following are the features of save device history option.

- Two formats of history are supported: FDM and DocuMint.
- Only one snapshot per device instance is allowed to be saved and you can save the snapshot of a device any number of times overwriting the existing one.

To save device history, perform the following steps.

1. On Device Home page, tap Tools.
2. Select **Save History** and tap **Select**

The **Save History** page appears.

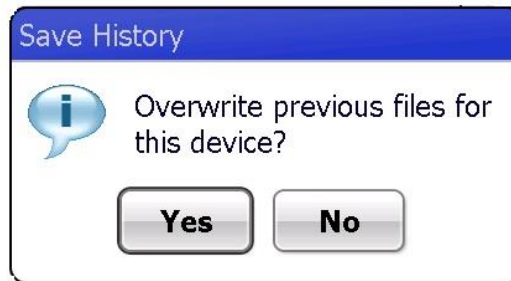
The screenshot shows a 'Save History' dialog box with the following fields and options:

- History Record Name:** A text input field containing 'NewDeviceRecord' with a pencil icon to its right.
- Device Tag:** A text input field containing 'DevTag' with a pencil icon to its right.
- Format:** Two radio button options: 'FDM' (which is selected) and 'Documint'.
- Buttons:** 'Save' and 'Return' buttons at the bottom of the dialog.

3. Enter the **History Record Name** using the keypad and tap **OK**. History Name field accepts alphanumeric characters, underscore, and no other special characters.
4. Enter the **Device Tag** using the keypad and tap **OK**. Device Tag field accepts alphanumeric characters, underscore, and no other special characters.

**Note:** The device can be identified with **History Record Name** and **Device Tag** in FDM, once the record is imported in FDM, provided the device is not already present in the FDM network.

5. Select the **Format**. The following are the available formats:
  - FDM
  - DocuMint
6. Tap **Save** to save device history record.
7. If a history record for this device already exists, the following warning message appears.



8. Tap **Yes** to overwrite the existing name. A overwrite success message appears.
9. Tap **OK** to return to **Device Home** page.

## Exporting device history records to FDM

The history snapshot saved in FDC can be imported into FDM for record and audit purposes. This is enabled by the standard Import/Export wizard in FDM. This way FDM allows to synchronize the device configuration data through the MC Toolkit handheld.

To export device history from FDC and import it in FDM, perform the following steps.

1. Connect your MC Toolkit handheld to your computer as described earlier.
2. Browse to the folder on your computer, **SD Card > FDC > Resources > History**.
3. The FDC history records are named as per the following convention for the primary name:  
**DeviceTag\_ManufacturerIDDeviceTypeDeviceRevisionDDRRevision\_DeviceID**
4. Copy the desired Device History Record files (with .fdm extension) from the above mentioned location to a temporary location on FDM Client computer.
5. Use FDM Import/Export wizard to import the history records into FDM. After you import successfully:
  - The snapshot would get imported into FDM database and appear as a history record for the corresponding device in FDM.
  - The Audit Trail entry for such a record identifies it as being imported through the MC Toolkit handheld.
  - If the device is not part of any of the FDM configured networks, it would appear under '**Disconnected Devices**' in FDM network view.
  - All operations allowed on Device History Record in FDM will be allowed for the record imported through the MC Toolkit handheld.

**Note:** For more details on using FDM Import/Export feature, refer to section Importing and Exporting Device History in FDM User's Guide.

## Exporting device history records to Documint

To export device history from FDC and import it in FDM, perform the following steps.

1. Connect your MC Toolkit handheld to your computer as described earlier.
2. Browse to the folder on your computer, **SD Card > FDC > Resources > History**.
3. The FDC history records are named as per the following convention for the primary name:  
**DeviceTag\_ManufacturerIDDeviceTypeDeviceRevisionDDRevision\_DeviceID**
4. Copy the desired Device History Record files (with .xml extension) from the above mentioned location to a temporary location on the DocuMint system.
5. For Importing in DocuMint: Select Procedures > Import or the Import option in the tool bar.



**Note:** For more details on using DocuMint Import feature, refer to section Importing from XML File in Document Help.

## Custom Views

FDC provides you a unique feature wherein you can choose what you want to view in a device and thus creating your own custom views. This is a very convenient utility when you are interested in select few variables in a device and saves you the time for navigating through the menus.

You can create two views per device type with maximum of 10 variables selected for each custom view.

To create/modify the custom views, perform the following.

1. On **Device Home** page, tap **My Views**.
2. Tap **Configure** and tap **Select**.  
The **Configure My Views** dialog box appears.
3. To customize **View1** and **View2**, select the variables by checking the box against desired variables.
4. Tap  or  to navigate to previous and next set of variables.
5. Once done, tap **Options** to select **Save My Views**.

Two custom views are ready with selected variables.

**Note:** Since a custom view can contain only up to 10 variables each, a warning is displayed if you have selected more than 10 variables.

To rename the views, perform the following.

6. Tap **Options > Rename View1**.  
A dialog box appears informing you to enter the name.
7. Tap **Ok**.
8. Tap **Option>Save** to persist the change
9. Tap **Return** to return to **My Views** page. You would see two options with the names you gave to the newly created views.

**Note:** To view the custom views, tap **My View 1 > Select**.

The My View 1 page appears.



Label	Value	Unit
▼ Config Cha...	32	
▼ Manufactu...	Honeywell	
▼ Model	ST3000	
▼ PV	0.00	s
▼ PV AO	0.000	mA
▼ PV LRV	5.5000	inH2O
▼ PV unit	inH2O	
▼ SV unit	degC	
▼ Tag	STT3K	
▼ Write prot...	No	

↓ Send

Return

The editing and other features are as explained in the earlier sections.

## 4.7 Offline configuration

### Overview

Offline Configuration refers to configuring a device when the device is not physically present or communicating with the application. This process enables you to create and save a configuration for a device, even when the device is not there physically. Later when the device becomes available with live communication, the same configuration can be downloaded to the device. This feature enables you to save on device commissioning time and even helps you to replicate the configuration in multiplicity of devices with lesser efforts. Currently, FDC does not support creating offline configuration. However, it supports importing of offline configuration from FDM R310 or later versions. The configurations thus imported can be downloaded to the device from FDC.

The following are the tasks that you need to perform for importing offline configuration in FDC application software and then downloading it to the device.

- Create offline configuration template in FDM
- Save the configuration in FDM in FDM format.
- Import the offline configuration in FDC
- Download the offline configuration to the device

**Note:** For details on creating and using offline configuration, refer to section Offline configuration in FDM User's Guide.

### Importing offline configuration

Using this feature you can import offline configuration template. The offline configuration template has to be created in FDM and saved in FDM format. Copy the .fdm files into the storage location of the FDC.

To import an offline configuration, perform the following steps.

1. On the FDC homepage, tap Offline Configuration > Select.

The **Offline Configurations** page appears.

2. Tap **Options > Import**.

The **Select a File** dialog box appears.

3. Navigate to the location where the offline configuration template is stored.
4. Select the required offline configuration template from the list.
5. Double-tap and the offline configuration template is imported.

A success message appears.

**Note:** In case if the offline configuration template is already imported, an overwrite message appears.

6. Tap **OK** to return to the **Offline Configurations** page. The device details appear on the bottom of the page.



## Deleting offline configuration

Using this feature you can delete an offline configuration template.

To delete an offline configuration, perform the following steps.

1. On the FDC homepage, tap **Offline Configuration > Select**.  
The **Offline Configurations** page appears.
2. Select the required offline configuration template from the list.
3. Tap **Options > Delete**. A warning message appears.
4. Tap **Yes** to delete the offline configuration template.

## Downloading an offline configuration

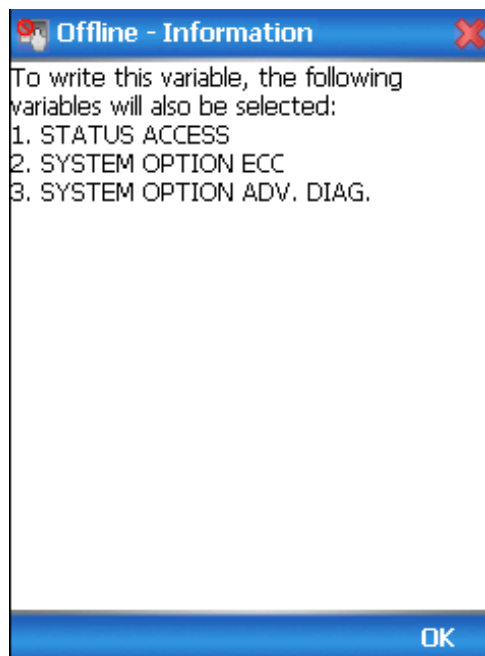
Using this feature, you can download the offline configuration when the device is online.

To download an offline configuration, perform the following steps.

1. On the FDC homepage, tap **Offline Configuration > Select**.  
The **Offline Configurations** page appears.
2. Select the required offline configuration template from the list.
3. Tap **Options > Download**.  
The **Offline – Select Variables** page appears with the all the variables.

**Note:** By default, all the variables selected in FDM will appear as selected and non-editable variables appear in grey color.

4. Select the required variable. In case you select a dependent variable, then variables on which it is dependent on will also be selected and the following warning appears.



5. Tap **OK** to return to the offline wizard.

6. Tap **Next**.

The **Offline – Review and Send** page appears with the list of selected variables.

7. Tap **Send** and the process to send the variables to the device starts. Once the downloading is complete, the following page appears.

Offline - Status		
Label	Value	Status
SV unit	degC	SUCC...
Transfer function	Linear	SUCC...
PV LRV	0	FAILED
PV unit	inH2O	SUCC...
Units	%	SUCC...
Date	1/1/80 12...	SUCC...
Descriptor	?????????...	SUCC...
Poll addr	0	SUCC...
PV URV	0	SUCC...

Send
Finish

**Note:** If the variables are downloaded successfully, status appears as **SUCCESS** in green color; and if failed, status appears as **FAILED** in red color.

8. Tap **Finish** to return to **FDC Homepage**.

## 5. Managing DE Devices using MC Toolkit Software

### 5.1 Starting MC Toolkit application

To start the MC Toolkit application, perform the following steps.

1. Turn on the MC Toolkit.

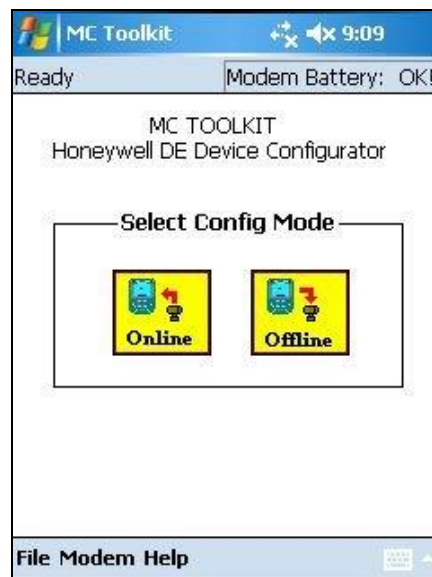
**Note:** For information on turning on the MC Toolkit, refer to section 3.5, Start up, Shutting down the MC Toolkit and 3.6 Application icons.

2. Select the MCToolkit icon

The MC Toolkit homepage appears.

### 5.2 Overview of MC Toolkit Homepage

MC Toolkit Homepage allows user to select the Configuration Mode; Online or Offline. It also offers menu options; File, Modem and Help. The details of the Menu are given under the Menu Bar topic.



#### Online and Offline Modes

Online: “Online” button allows you to establish connection to a device and allows following operations:

- upload of the device database
- configuration of parameters,
- Calibration and
- Diagnostics.

In addition, the online configuration allows saving the current configuration to a file

The following devices are supported:

- Honeywell Smart Pressure Transmitters: ST 3000, ST 800
- Honeywell Smart temperature Transmitters: STT25M, STT25D, STT350

Offline: “Offline” button allows you to select a basic offline template, edit the parameters and download to a device after establishing connection. The updates to the parameters can also be saved into the file without actually downloading to the device. Complete detail is provided under “[Offline Configuration](#)” section 5.6



## 5.3 MC Toolkit Application Software Display Conventions

### Navigation

#### Menu Buttons

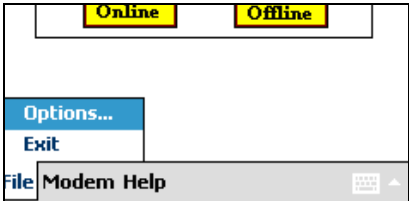
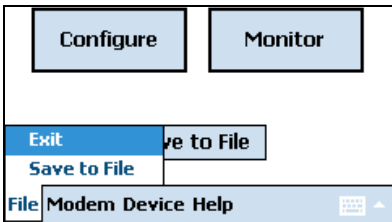
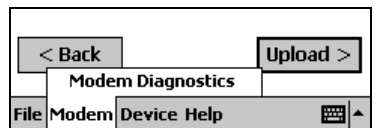
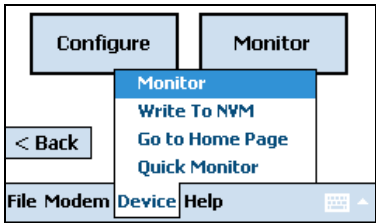
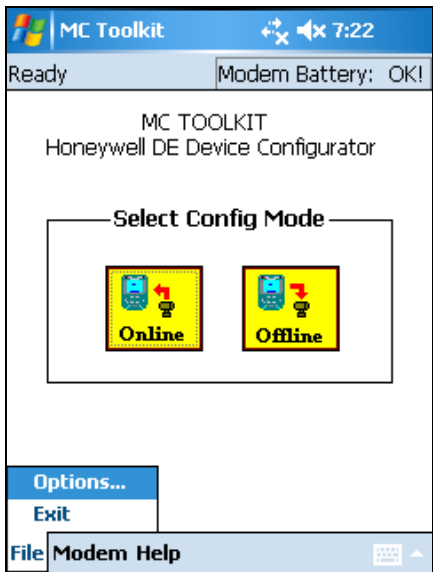
In general, selecting a button in a display will call up the next-lower-level display, whose title is the same or similar to the label on the button. A menu tree for Honeywell DE Displays is given under Menu Bar, Menu Selections and HELP display table.

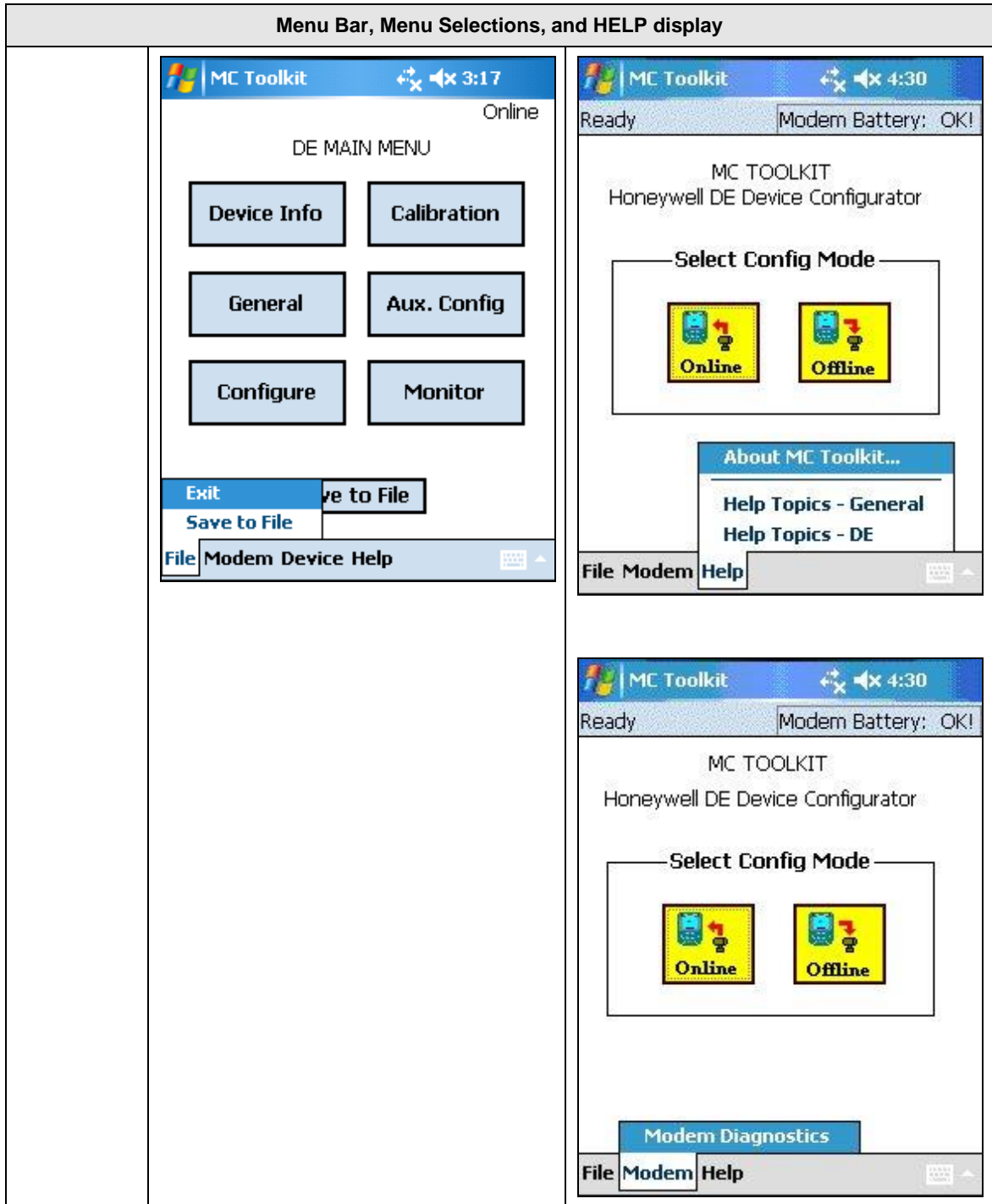
#### Back Button

In general, selecting the **Back** button at the bottom of any display will call up the previous display.

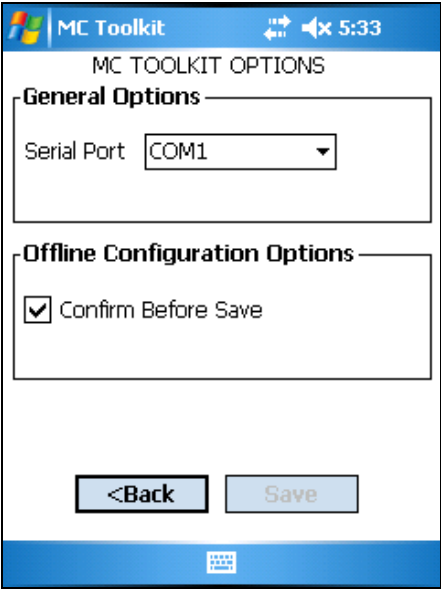

In most displays, the Back button is at bottom-right or bottom-center. When it appears at bottom-left, along with a left-pointing arrow, it indicates that selecting the **Back** button will necessitate a new Upload.

### Menu Bar

Menu Bar, Menu Selections, and HELP display	
<p><b>Menu selections</b></p> <p>The menu bar, at the bottom of each display, enables you to perform file, diagnostic, and utility functions.</p> <p>Typical displays are shown below. Menu selections are shown in detail at right.</p>	<p>File menu on Startup screen:</p>  <p>File menu in Online mode:</p>   
	



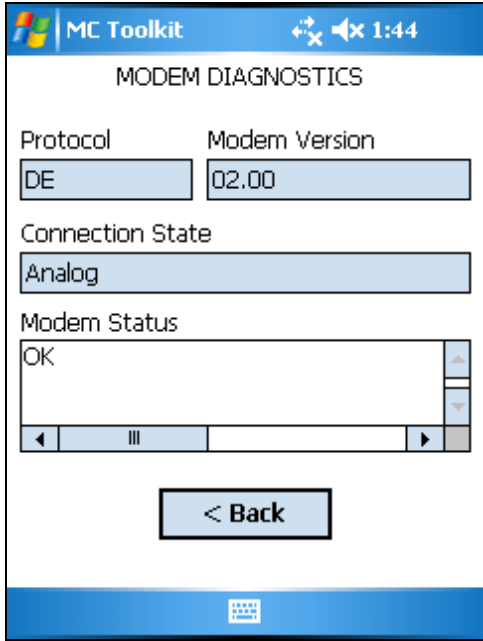
## File Menu

<p><b>File (Startup screen)</b></p>	<p><b>Exit</b> Closes the MC Toolkit application</p> <p><b>Options</b> Calls up the MC Toolkit OPTIONS Dialog. See <a href="#">MC Toolkit Options dialog</a> for details.</p>	 <p>General Options allows selection of COM4 Port.</p> <p>Offline Configuration Options has Offline Configuration Settings. The details will be under “<b>MC Toolkit Options dialog</b>” section</p>
<p><b>File (Online mode)</b></p>	<p><b>Exit</b> Closes the MC Toolkit application</p> <p><b>Save to File</b> Enables export of database parameters in XML format, which can be used by other programs such as DocuMint. (Refer to the Reference Data section 5.8 for more information.) This selection is not available until a transmitter database has been uploaded.</p>	<p>To export an XML file, select File, Save To File. A popup message appears.</p> <p>Select the <b>OK</b> button.</p> 

## Modem Menu

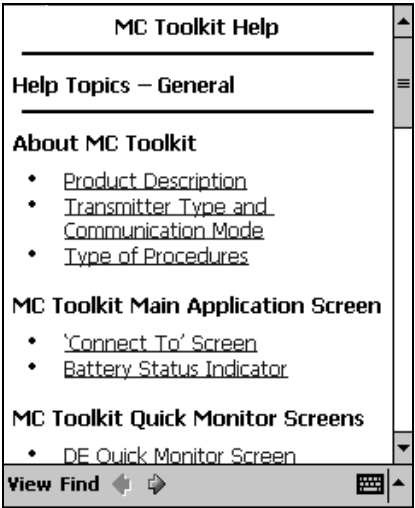
Note: Before you begin Upload or Download operation it is important to make sure that the modem status is good.

Select Modem\Modem Diagnostics and make sure that BOTH Modem Battery and Modem Status are OK. Do not continue in case of any bad status.

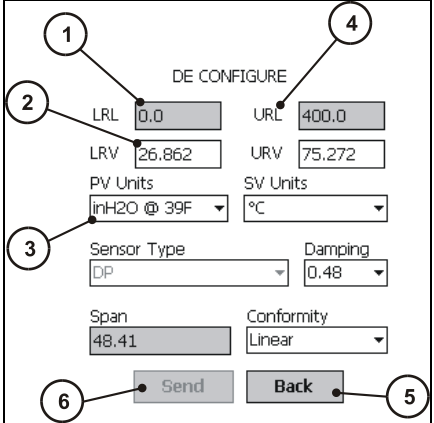
<p><b>Modem Diagnostics</b></p>	<p>Modem Battery: Must display Ok to proceed</p> <p>Modem Version: Current Modem firmware version on the xx.xx form</p> <p>Protocol – Always DE (This information is for diagnostic purposes since the modem can handle both HART and DE protocols)</p> <p>The Connection State may be:</p> <ul style="list-style-type: none"> <li>• Analog</li> <li>• 4 Byte DE</li> <li>• 6 Byte DE</li> </ul> <p>Modem status may be Ok to proceed.</p> <ul style="list-style-type: none"> <li>• Modem ROM Failure!</li> <li>• Modem RAM Failure!</li> <li>• Modem Battery is Low!</li> </ul>	
---------------------------------	--	---



## Help Menu

<p><b>HELP display</b></p>	<p>The Help display is available whenever the MC Toolkit is active.</p> <p>It includes three groups of topics, each of Selectable from the <b>Help</b> Menu</p> <ul style="list-style-type: none"> <li>- General</li> <li>- DE</li> </ul> <p>Each group includes a list of topics. Each topic (in blue, underlined letters) is selectable to provide direct access to the Help information.</p> <p>Dragging the cursor in the scrollbar at right enables viewing of all three groups of topics. At the bottom of each group, a Back to Top selection moves the display to the beginning of the first group of topics.</p> <p><b>Note:</b>          The <b>View, Find</b> and (arrows) selections at the bottom of the screen apply to the Help that applies to the Pocket PC, and not to the MC Toolkit application.</p>	
<p><b>About MC Toolkit</b></p>	<p>Shows the Product Description</p> <p>Type of Transmitter and Communications being used</p> <p>Type of procedures that can be configured</p>	

## Data Entry and Display

Key number / Description	Illustration: Key Numbers
<p>1. Box with no arrow and with gray background indicates a read-only (R/) field. Numeric or text values in transmitter are displayed only; user entry or modification is not permitted.</p> <p>2. Box with white background and with no arrow indicates Read/Write (R/W) text or numeric input field. Values previously stored in memory (of the transmitter or of the MC Toolkit) are displayed. You can enter or modify values using an appropriate Input Method (e.g., Keyboard).</p> <p>Entering a new value turns the background yellow, indicating that the value in the box is different from the value in memory.</p> <p>When the <b>Send</b> button (6) is selected, the value in the box is copied to memory in the transmitter, and the background color returns to white.</p> <p>If you exit the screen before using the Send button, the changes will be ignored.</p> <p>3. Box with white background and arrow at right indicates a read/write (R/W) selection list. The value previously selected and stored in memory is displayed. Selecting the arrow at right presents a list of available selections, and selecting an item from the list places it in the selection box.</p> <p>If you exit the screen before using the Send button, the changes will be ignored.</p> <p>4. The label above the box indicates the meaning of the data inside the box.</p> <p>5. The <b>Back</b> button at the bottom of the display causes the display that was viewed previously to return the screen.</p> <p>6. The <b>Send</b> button is at half intensity when no values have been changed. It changes to full intensity when one or more of the boxes contain a changed value. Selecting the <b>Send</b> button when it is highlighted will copy all changed values to memory, and the button will return to half-intensity.</p>	 <p>The illustration shows a 'DE CONFIGURE' screen with the following elements:</p> <ul style="list-style-type: none"> <li><b>1:</b> LRL input field with a gray background.</li> <li><b>2:</b> LRV input field with a white background.</li> <li><b>3:</b> PV Units dropdown menu with a white background and a right-pointing arrow.</li> <li><b>4:</b> URL input field with a gray background.</li> <li><b>5:</b> Back button at the bottom right.</li> <li><b>6:</b> Send button at the bottom left.</li> </ul> <p>Other visible fields include URV (75.272), SV Units (°C), Sensor Type (DP), Damping (0.48), Span (48.41), and Conformity (Linear).</p>

## 5.4 Overview of device configuration

Using online configuration, you can configure, calibrate, monitor and diagnose a DE device which is connected to MC Toolkit. After making changes to the device you can also save the current configuration of the device into a file that can be used in Offline mode to download to other similar devices.

## 5.5 Online configuration

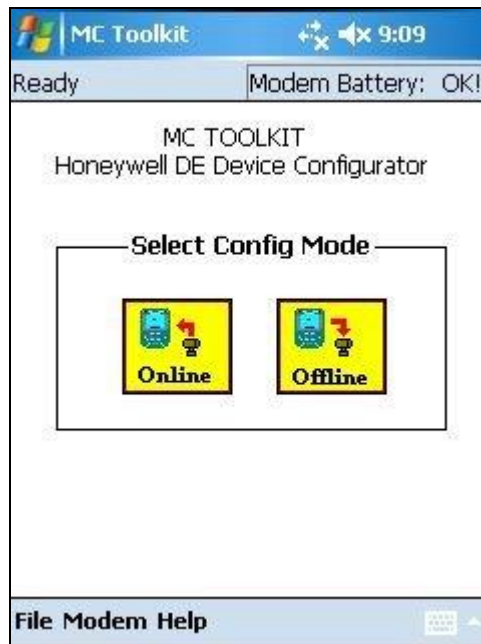
### Detecting and loading a device

“Online” button allows you to establish connection to a device and do Online operations

### Online Mode Introduction

This section contains procedures for using the **MC Toolkit application software** to communicate with Honeywell DE Transmitters.

On the Homepage select “Online” button to proceed with Online Configuration features.



For specific data relating to parameters involved in the procedures, refer to [Reference Data in section 5.8](#)

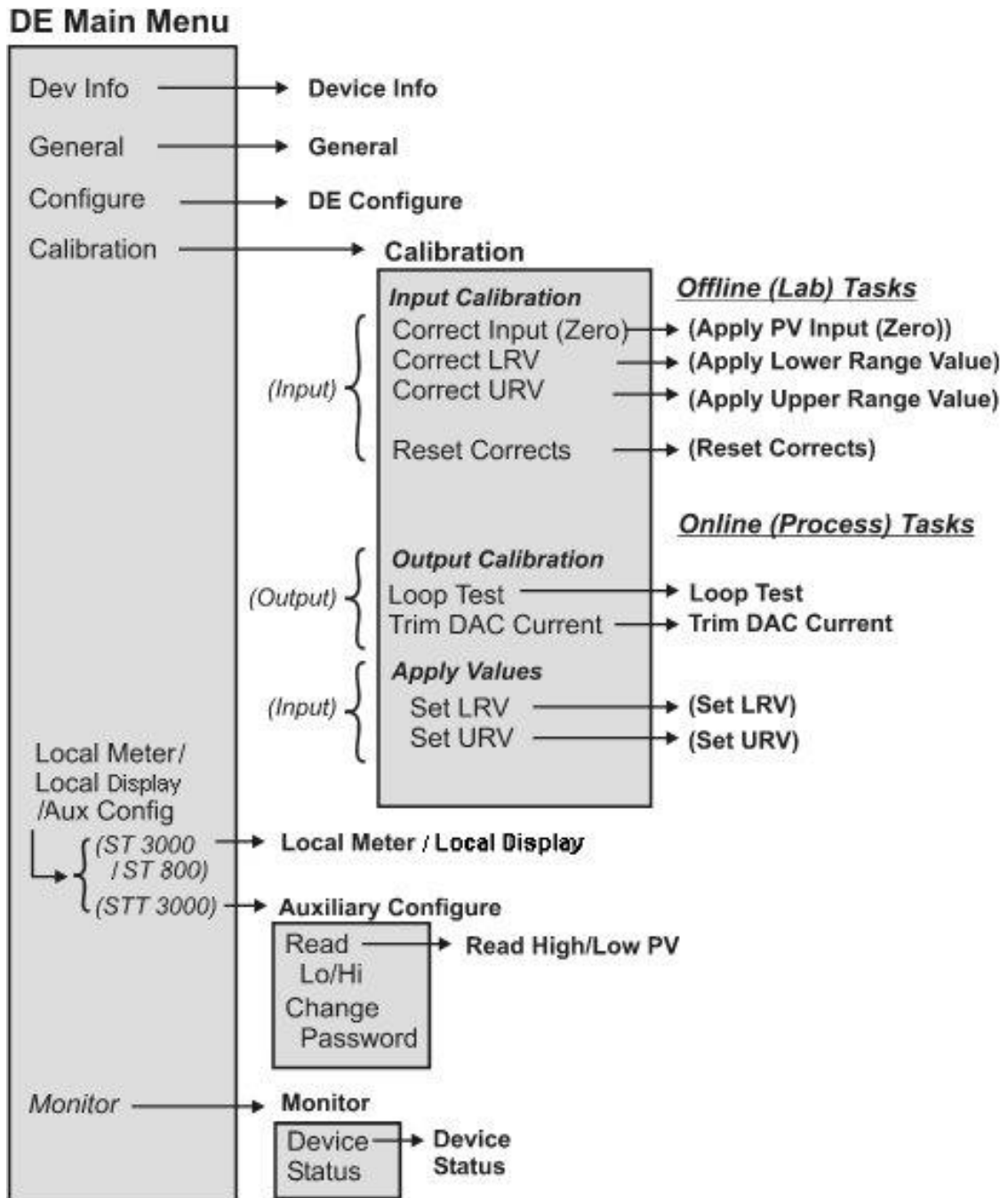


Figure 5-1 Menu Tree - Honeywell DE Displays

## Summary of Operating Procedures

To access displays for Honeywell DE Transmitters:

- Start the MC Toolkit application; the MC TOOLKIT ... display will appear. [Refer to 5.1 Starting MC Toolkit application.](#)
- Upload the database from the transmitter. (The QUICK MONITOR display will enable viewing of key parameters before taking the time for database uploading.) The DE MAIN MENU appears. (Refer to [5.3 MC Toolkit Application Software Display Conventions](#) in this section.)
- Select the appropriate display from the DE MAIN MENU. (Refer to Table 11 DE Displays / Tasks Summary in this section, and to the list of DE displays.)

The content of each display is summarized in Table 11.

**Note:** Only the Basic display is available for the STT 750 Temperature Transmitter.

**Table 11 DE Displays / Tasks Summary**

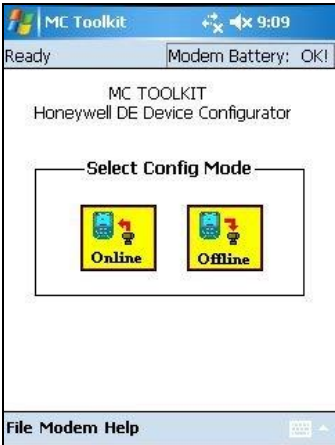
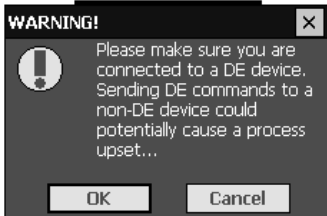




Menu Item	Task	
DEVICE INFO	<u>Enter:</u> Device Type: <ul style="list-style-type: none"> <li>• Tag ID</li> <li>• Message (in Scratch Pad)</li> </ul>	<u>Observe (Read):</u> <ul style="list-style-type: none"> <li>• Type</li> <li>• Serial Number</li> <li>• Firmware Version</li> </ul>
GENERAL	<u>Select:</u> <ul style="list-style-type: none"> <li>• PV Type</li> </ul> <u>Enter:</u> <ul style="list-style-type: none"> <li>• Comm Mode</li> <li>• Line Filter (STT)</li> <li>• T/C Fault Detect (STT)</li> </ul>	<u>Observe (Read):</u> <ul style="list-style-type: none"> <li>• Failsafe Direction</li> </ul>
DE CONFIGURE	<u>Select:</u> <ul style="list-style-type: none"> <li>• PV Units</li> <li>• SV Units</li> <li>• Conformity (ST)</li> <li>• Damping</li> <li>• Sensor Type (STT)</li> <li>• Linear</li> </ul> <u>Enter:</u> <ul style="list-style-type: none"> <li>• LRV</li> <li>• URV</li> </ul>	<u>Observe (Read):</u> <ul style="list-style-type: none"> <li>• LRL</li> <li>• URL</li> <li>• Span</li> <li>• Sensor Type (ST)</li> </ul>
CALIBRATION	<u>Enter/Select:</u> <ul style="list-style-type: none"> <li>• Correct Input (Zero)</li> <li>• Correct Input (LRV)</li> <li>• Correct Input (URV)</li> <li>• Reset Corrects (Zero, LRV, URV)</li> <li>• Loop Test (Check Analog Output Level)</li> <li>• Trim DAC Current (Calibrate output current)</li> <li>• Apply Values (that is, re-range LRV and URV to PV input)</li> </ul>	<u>Observe (Read):</u> <ul style="list-style-type: none"> <li>• Input at Zero, LRV, and URV</li> <li>• (Verify) Reset Corrects</li> <li>• Loop Current (continuity)</li> <li>• Output Current level (at 0 %, 100%)</li> <li>• Applied values of LRV and URV</li> </ul>

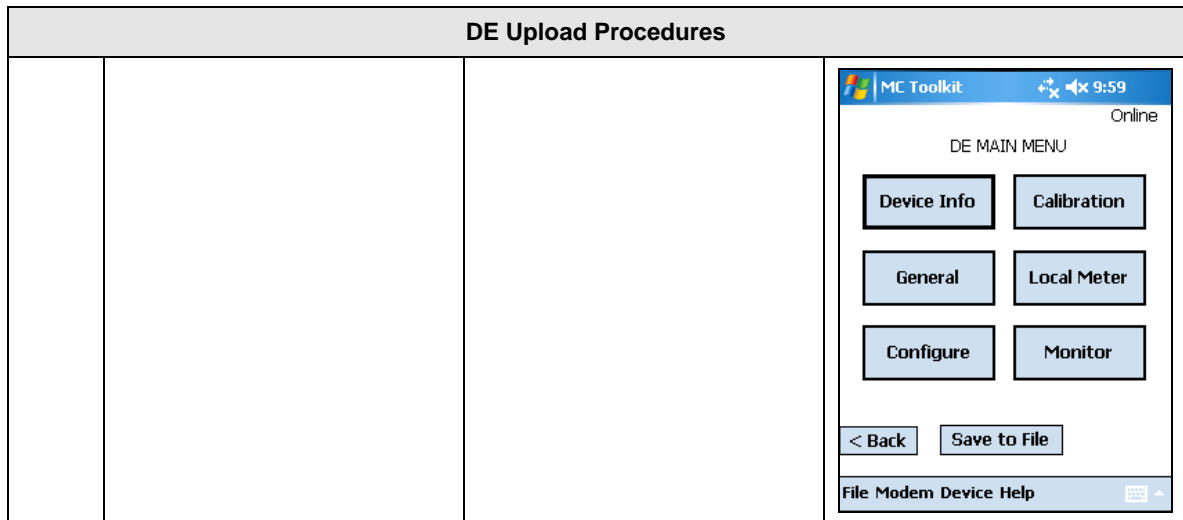
LOCAL METER	<u>Select:</u> <ul style="list-style-type: none"> <li>• Meter Units (EU)</li> </ul> <u>Enter:</u> <ul style="list-style-type: none"> <li>• Custom Units</li> <li>• (Custom) Flow (EU) value: Upper, Lower</li> </ul>	<u>Observe (Read):</u> <ul style="list-style-type: none"> <li>• Meter Hardware Type</li> </ul>
LOCAL DISPLAY	<u>Select:</u> <ul style="list-style-type: none"> <li>• Display Units (EU)</li> </ul> <u>Enter:</u> <ul style="list-style-type: none"> <li>• Custom Units</li> <li>• (Custom) Flow (EU) value: Upper, Lower</li> </ul>	<u>Observe (Read):</u> <ul style="list-style-type: none"> <li>• Display Hardware Type</li> </ul>
LOCAL DISPLAY (STT 850/750)	<u>Select (read / Write)</u> <ul style="list-style-type: none"> <li>• Screen Format</li> <li>• PV Selection</li> <li>• Screen Units</li> <li>• Decimals</li> <li>• Scrn Rotation</li> <li>• Rotation Time</li> </ul>	<u>Observe (Read):</u> <ul style="list-style-type: none"> <li>• Display Type</li> <li>• Sensor Input</li> <li>• Sensor Mode</li> </ul>
	<b>STT850 ONLY:</b> <u>Enter (Read / Write):</u> <ul style="list-style-type: none"> <li>• Bar Low Limit</li> <li>• Bar High Limit</li> <li>• Trend Duration</li> </ul>	
MONITOR		<u>Observe (Read):</u> <ul style="list-style-type: none"> <li>• Input value</li> <li>• Output value</li> <li>• Secondary (Input) value</li> <li>• Gross Status (code)</li> <li>• Device Status (Messages)</li> </ul>
Auxiliary Configuration (STT 3000)	<u>Select:</u> <ul style="list-style-type: none"> <li>• Critical Status Latching</li> <li>• Write Protection</li> <li>• NAMUR</li> <li>• CJ Compensation</li> </ul> <u>Enter:</u> <ul style="list-style-type: none"> <li>• CJ Temp</li> <li>• Password (Write Protection)</li> <li>• New Password</li> </ul>	<u>Observe (Read):</u> <ul style="list-style-type: none"> <li>• High/Low PV Values</li> </ul>

## Procedural Considerations

De device Upload, Configuration and Calibration procedures are listed in the tables below.

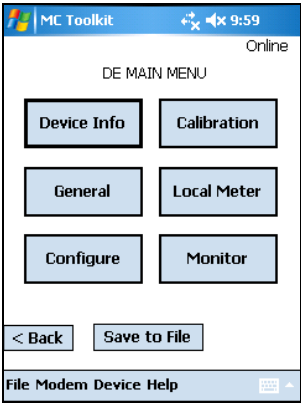
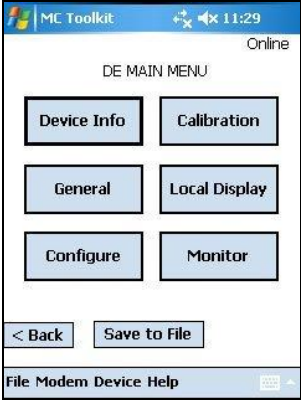
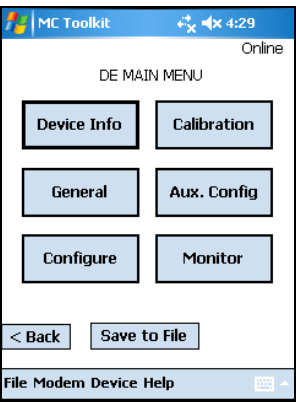
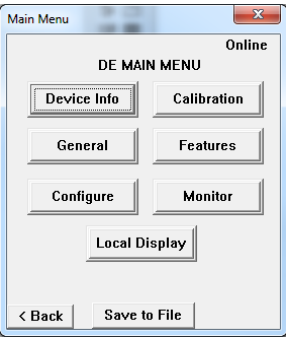

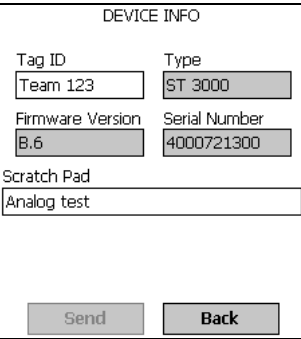
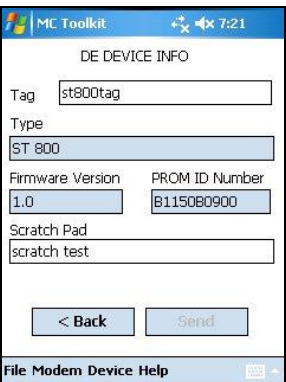
**Table 12 DE Upload Procedures**

DE Upload Procedures			
		<p>Select the <b>Online</b> button                  This Warning message appears.</p> 	<p>If the MC Toolkit <i>is</i> connected to a DE Device, select the <b>OK</b> button.</p>
	<p><b>Note:</b>                  This Warning appears only if the transmitter is configured for operation in analog mode.</p>  <p><b>WARNING!</b>                  Before proceeding, if the transmitter is part of a control loop, ensure that interlocks and alarms are secured and that the loop is in Manual control.</p> <p>Then, select the <b>OK</b> button in the popup message. The display at right appears.</p>	 <p>Use this display to</p> <ul style="list-style-type: none"> <li>- Verify device identification and to monitor Gross Status process conditions</li> <li>- Select the desired Units for the Process Variable input using the <b>PV Units</b> drop-down list.</li> </ul>	<p>Select the <b>Upload</b> button; the wait cursor and progress bar appear.</p>  <p>Then, the Main Menu for the Transmitter appears.</p>

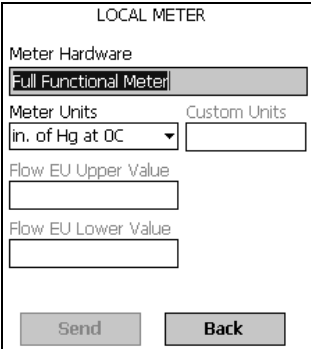
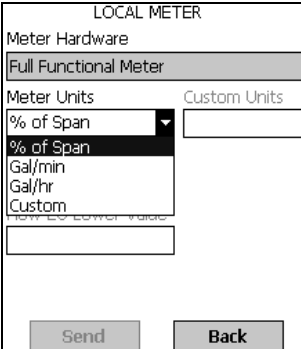
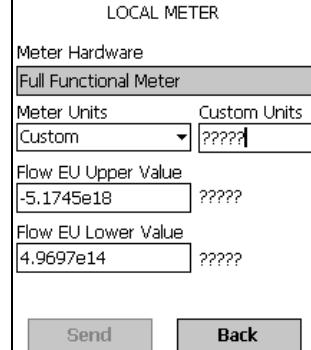
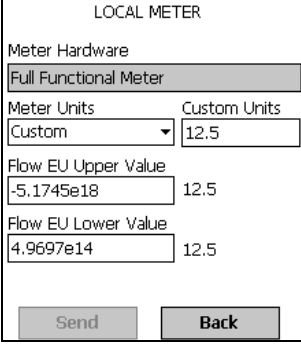
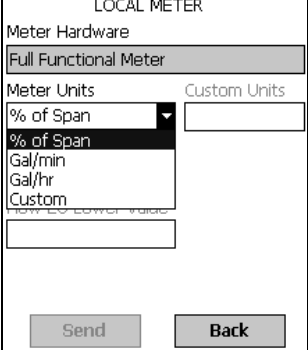
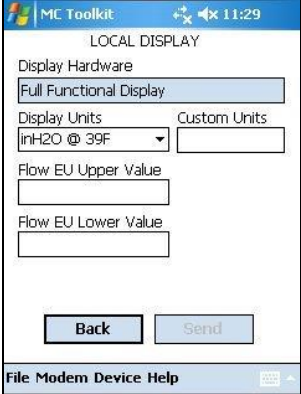




**Table 13 DE Main Menu Procedures**

DE Main Menu Procedures			
<p><b>DE Main Menu</b></p>	<p style="text-align: center;"><b>(ST 3000)</b></p>  <p style="text-align: center;"><b>ST 800</b></p> 	<p style="text-align: center;"><b>(STT 3000)</b></p>  <p style="text-align: center;"><b>ST850/STT750 Local Display Support</b></p> 	<p><b>Note:</b>                  This message appears if the &lt;Back button is selected if the transmitter was set to Output Mode (in Calibration procedures), and the Output was not later cleared.</p> <p><b>CONFIRM!</b>   The transmitter is still in output mode. Are you sure you want to leave the DE Main Menu?</p> <p><input type="button" value="Yes"/> <input type="button" value="No"/></p> <p><b>Various buttons are provided on the Main Menu to navigate to different screens. Save to File allows saving the current device configuration to a file. More detail on this under "Save To File in Online Mode" Procedure</b></p>
<p><b>Device Info</b></p>	<p style="text-align: center;">DEVICE INFO</p> 	<p style="text-align: center;">DE DEVICE INFO</p>  <p>Type field will show "ST 800" when ST 800 device is connected</p>	<p><b>Tag ID (r/w)</b>                  User ID up to 8 alphanumeric characters (suggestion: relate to functional process entities and/or plant areas).</p> <p><b>Type (r)</b>                  Manufacturer's device type identifier (typically, a model number)</p> <p><b>Firmware Version (r)</b>                  Manufacturer's Firmware version identifier</p> <p><b>Serial Number (r)</b>                  Manufacturer</p> <p><b>Scratch Pad (r/w)</b>                  Up to 32 alphanumeric characters (suggestion: messages to control room regarding observed/assigned operational status)</p>

<b>DE Main Menu Procedures</b>			
<b>General</b>	<p style="text-align: center;"><b>(ST 3000 / ST 800)</b></p> <div style="border: 1px solid black; padding: 5px;"> <p style="text-align: center;">GENERAL</p> <p>PV Type Single Range</p> <p>Communication Mode DE 6 Byte</p> <p>Failsafe Direction Upscale</p> <p style="text-align: center;">Send    Back</p> </div>	<p style="text-align: center;"><b>(STT 3000)</b></p> <div style="border: 1px solid black; padding: 5px;"> <p style="text-align: center;">GENERAL</p> <p>PV Type Single Range</p> <p>Communication Mode Analog</p> <p>Failsafe Direction    Line Filter Upscale    60 Hz</p> <p>T/C Fault Detect Disabled</p> <p style="text-align: center;">Send    Back</p> </div>	<p><b>PV Type (r/w)</b> Select: Dual Range (STDC) or Single Range or Single Range w/SV</p> <p><b>Communication Mode (r/w)</b> Select: Analog or DE 4 Byte or DE 6 Byte</p> <p><b>FS Direction (r)</b> (Upscale or Downscale; selection is jumpered in the transmitter).</p> <p><b>Line Filter (r)</b> Select: 50hz or 60hz.</p> <p><b>T/C Fault Detect (r/w):</b> Select: Enabled or Disabled.</p>
<b>DE Configure</b>	<p style="text-align: center;"><b>ST 3000 / ST 800</b></p> <div style="border: 1px solid black; padding: 5px;"> <p style="text-align: center;">DE CONFIGURE</p> <p>LRL 0.0    URL 400.0</p> <p>LRV -0.021553    URV 224.42</p> <p>PV Units linH2O @ 39F    SV Units °C</p> <p>Sensor Type DP    Damping 0.48</p> <p>Span 224.44    Conformity Linear</p> <p style="text-align: center;">Send    Back</p> </div> <p style="text-align: center;"><b>STT 3000</b></p> <div style="border: 1px solid black; padding: 5px;"> <p style="text-align: center;">DE CONFIGURE</p> <p>LRL 0.0    URL 400.0</p> <p>LRV -1.4424    URV 49.36</p> <p>PV Units °C    SV Units °C</p> <p>Sensor Type T/C-J    Damping 3.10</p> <p>Span 50.802    Linearization Linear</p> <p style="text-align: center;">Send    Back</p> </div>	<p><b>LRL (r):</b> Lower Range Limit</p> <p><b>URL (r):</b> Upper Range Limit</p> <p><b>LRV (r/w):</b> Lower Range Value</p> <p><b>URV (r/w):</b> Upper Range Value</p> <p><b>PV Units (r/w)</b> Selection of scaling value (default: inches of H<sub>2</sub>O @ 39°F)</p> <p><b>SV Units (r/w)</b> Selection of scaling value (°C/°F)</p> <p><b>Sensor Type (r)</b> Sensor Type associated with the transmitter</p> <p><b>Damping (r/w)</b> Selection of level of digital noise reduction</p> <p><b>Span (r)</b> Process Range (URL - LRL)</p> <p><b>Conformity (r/w) (ST 3000 / ST 800)</b> Selection of conformity to input form: Linear or Square Root</p> <p><b>Linearization (r/w) (STT 3000)</b> Selection of conformity to input form: Linear or Non Linear</p>	
<b>Calibration</b>	<div style="border: 1px solid black; padding: 5px;"> <p style="text-align: center;">CALIBRATION</p> <p><b>Input Calibration</b></p> <p>Corr. Input (zero)    Correct LRV</p> <p>Reset Corrects    Correct URV</p> <p><b>Output Calibration</b>    <b>Apply Values</b></p> <p>Loop Test    Set LRV</p> <p>Trim DAC Curr.    Set URV</p> <p style="text-align: center;">Back</p> </div>	<p>For more information, refer to: Table 14, Table 15, Table 16, Table 17.</p>	

DE Main Menu Procedures			
<p><b>Local Meter</b> (ST 3000)</p>			<p><b>Meter Hardware (r)</b> Type designation of meter associated with the transmitter</p> <p><b>Meter Units (r/w)</b> Selection EUs for Local Meter</p> <p><b>Custom Units (r/w)</b> (Refer to Transmitter User Manual).</p> <p><b>Flow EU Upper Value (r/w)</b> Selection of standard Engineering Units for Flow Upper Value</p> <p><b>Flow EU Lower Value (r/w)</b> Selection of standard Engineering Units for Flow Lower Value</p>
<p><b>Local Meter</b> (ST 3000 example)</p>			
<p><b>Local Display</b> (ST 800)*</p>		<p><b>Display Hardware (r)</b> Type designation of display associated with the transmitter</p> <p><b>Display Units (r/w)</b> Selection EUs for Local Display</p> <p><b>Custom Units (r/w)</b> (Refer to Transmitter User Manual).</p> <p><b>Flow EU Upper Value (r/w)</b> Selection of standard Engineering Units for Flow Upper Value</p> <p><b>Flow EU Lower Value (r/w)</b> Selection of standard Engineering Units for Flow Lower Value</p>	<p>*ST 800 supports Advanced and Basic Display. Custom Units is Supported only in Advanced Display</p>

**Local Display  
(STT 850/ 750)**

MC Toolkit 4:21

Display Type: Advanced

Input Model: Dual Input | Loop Mode: Redundant

Screen Format: Horizontal Trend

PV Selection: Sensor 1

Units: °C | Decimls: x.x

Trend Duration: 1 hrs

Disply Lo Lim: 0.0 | Disply Hi Lim: 34.0 | Rotation Time: 8 sec

Scrn Rotation: Disable

< Back Send

File Modem Device Help

MC Toolkit 4:21

Display Type: Advanced

Input Model: Dual Input | Loop Mode: Redundant

Screen Format: Bar Graph

PV Selection: Loop PV

Units: °C | Decimls: x.x

Trend Duration: 1 hrs

Disply Lo Lim: 0.0 | Disply Hi Lim: 34.0 | Rotation Time: 8 sec

Scrn Rotation: Disable

< Back Send

File Modem Device Help

**Display Type:**

- Not Connected
- Advance Display
- Basic Display

**Input Model (Sensor input Mode)**

- Single input
- Dual input

**Loop Mode (Sensor Mode)**

- sensor 1
- Redundant Mode
- Delta Mode

**Screen Format**

- None
- Large PV
- Bar Graph (Applicable for only Advance Display, STT850 only)
- Horizontal Trend (Applicable for only Advance Display, STT850 only )

**PV Selection: For Dual input Models:**

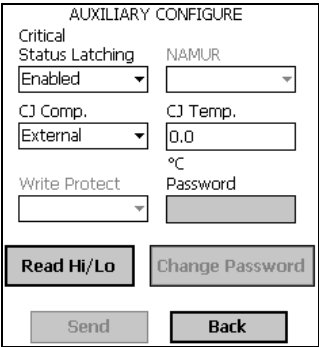
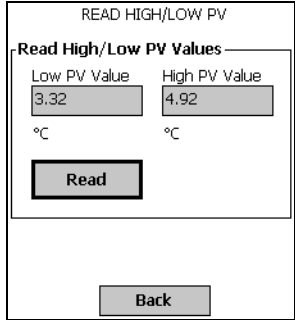
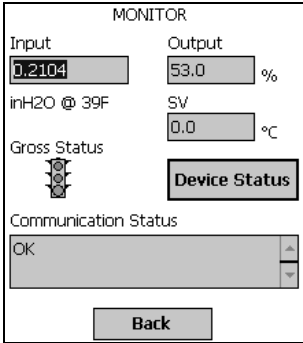
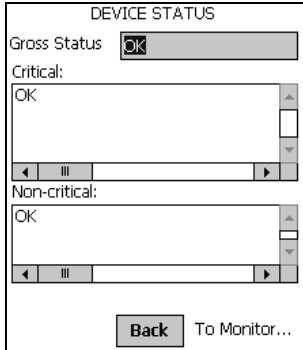
- Loop PV (C,F,R,K,Ohm,MV)
- CJ Temperature (C,F,R,K)
- Sensor 1 (C,F,R,K,Ohm,MV)
- Sensor 2 (C,F,R,K)
- Sensor Delta (C,F,R,K)
- Sensor 1 Resistance (Ohm)
- Sensor 2 Resistance (Ohm)
- Loop Output (mA)
- Percent Output (%)

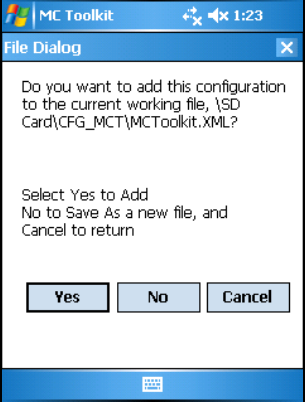
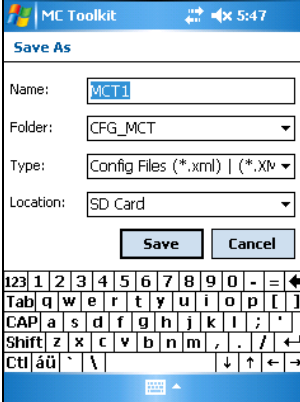
**PV Selection: For Single input Models:**

- Loop PV
- CJ Temperature
- Sensor
- Sensor Resistance
- Loop Output (mA)
- Percent Output

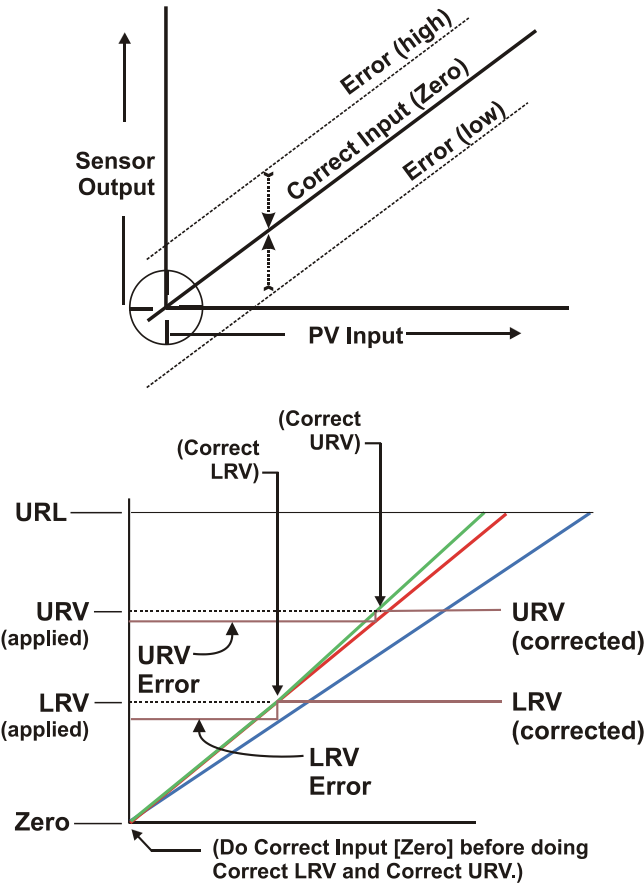
**Units (Screen Units)**

- degC
- degF
- Rankine
- Kelvin
- Millivolt
- Ohm
- Percent
- Milliamps

		<p><b>Decimals</b></p> <ul style="list-style-type: none"> <li>• X</li> <li>• X.X</li> <li>• X.XX</li> <li>• X.XXX</li> </ul> <p><b>Display Lo Lim : Display Low Limit: Floating point value</b></p> <p><b>Display Hi Lim : Display High Limit: Floating point value</b></p> <p><b>Trend Duration (1 – 999 hours) :</b> Integer value (applicable to PV format of Trend type)</p> <p><b>Scrn Rotation (Disable / Enable) :</b> Enable makes the Display Rotate the formatted screens at the interval specified by the Screen Rotation time</p> <p><b>Rotation Time:</b> 3 to 30 seconds</p>	
<p><b>Auxiliary Configure</b></p>		<p><b>Critical Status Latching</b>          Select Enabled or Disabled.</p> <p><b>NAMUR</b>          Select Enabled or Disabled.          (Disable requires that Write Protect is set to Not Write Protected.)</p> <p><b>CJ Temp.</b>          Enter External Cold Junction Temperature.</p> <p>Select the <b>Read HI/LO</b> button to call up the <b>READ HIGH/LOW PV</b> display.</p>	<p>Select the <b>Read</b> button to display the lowest and the highest PV values since last read.</p> 
<p><b>Monitor</b></p>	 <p><b>Input (r)</b>          Sensor input in Engineering Units</p> <p><b>Output (r)</b>          Loop output as percent of Span</p>	<p><b>SV (r)</b>          Secondary Variable in Engineering Units</p> <p><b>Gross Status (r)</b>          Gross transmitter status. Select the <b>Device Status</b> button to call up the Device Status display.</p> <p><b>Communication Status (r)</b>          For status information, refer to the section on Messages and Diagnostic Codes.</p>	

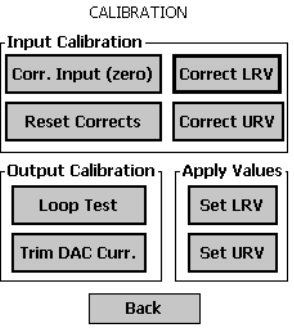
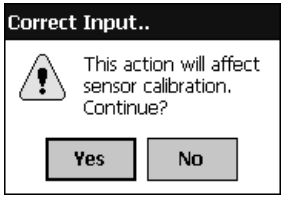
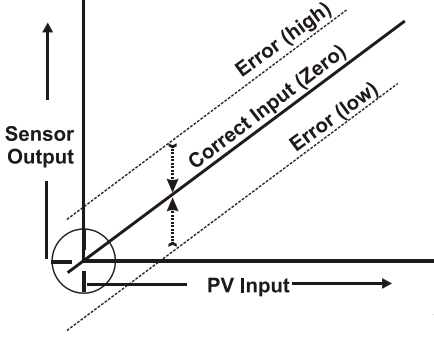
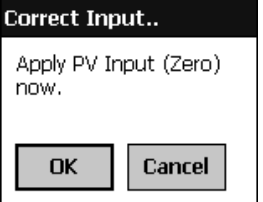
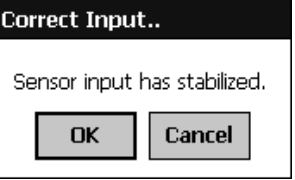
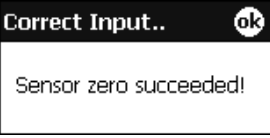
<p><b>Save To File in Online Mode</b></p>	 <p>The screenshot shows a 'File Dialog' window with the following text: 'Do you want to add this configuration to the current working file, \SD Card\CFG_MCT\MCToolkit.XML?' Below this, it says 'Select Yes to Add, No to Save As a new file, and Cancel to return'. At the bottom, there are three buttons: 'Yes', 'No', and 'Cancel'.</p>	 <p>The screenshot shows a 'Save As' dialog window. The 'Name' field contains 'MCT1'. The 'Folder' dropdown is set to 'CFG_MCT'. The 'Type' dropdown is set to 'Config Files (*.xml)   (*.XN)'. The 'Location' dropdown is set to 'SD Card'. There are 'Save' and 'Cancel' buttons at the bottom. A virtual keyboard is visible below the dialog.</p>	<p>On the MAIN MENU screen the “Save to File” sub menu is listed under the File menu. A Save to File button is also located on the MAIN MENU screen. Both the “Save to File” options provide you with the same functionality.</p> <p>Select “Save to File” and you get the screen on the far left</p> <p>Selecting “Yes” adds the current online configuration into the current working file.</p> <p>Selecting No, brings up the “Save As” screen. The location and folder are set to SD Card and CFG_MCT. You can type in a new name for the file. The default name will be “New1”.</p> <p>The configuration will be saved in the *.xml file under SD Card/CFG_MCT folder on your MC Toolkit / MCT 303. You can copy the saved configuration file to PC and view it in a browser as it is, or Import the data into Excel for further file management. Follow “How to view the Saved Configuration file and Import to Excel”? Section 5.6.</p>
---	--	---	--

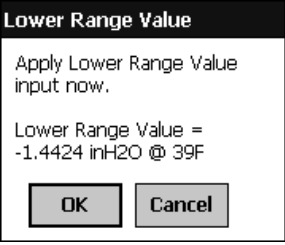
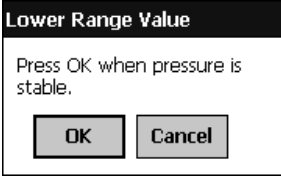
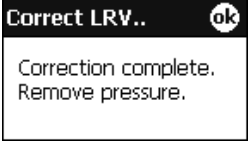
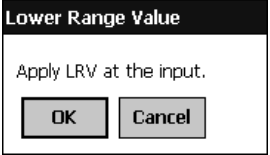
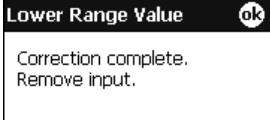
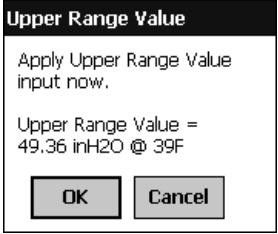
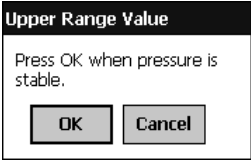
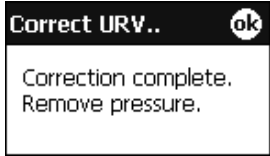
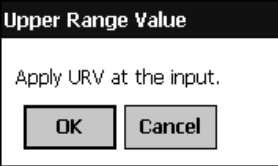
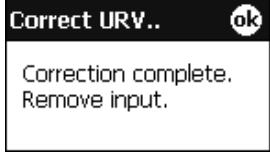
**Table 14 Input Calibration (DE Transmitters) –  
 Correct Input (Zero), LRV, URV; Reset Corrects**

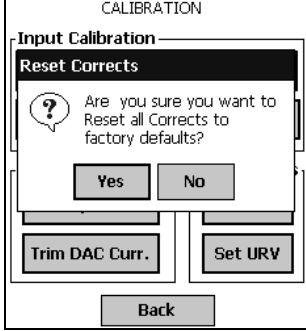
Input Calibration (DE Transmitters) - Correct Input (Zero), LRV, URV; Reset Corrects	
<p><b>Requirements:</b></p> <ul style="list-style-type: none"> <li>• Input source, with accuracy of at least 0.04%</li> <li>• resistor, at least 250-ohms</li> <li>• Voltmeter or Ammeter</li> <li>• 24 Vdc Power Supply (nominal)</li> <li>• Clean work area with suitable environmental conditions.</li> <li>• Pressure Transmitter must be level.</li> </ul> <p><b>Overview of Procedures:</b></p> <p>The Zero-Correct procedure establishes the correct <b>vertical positioning</b> of the response profile.</p> <p>The LRV Correct and URV Correct procedures establish the correct <b>slope</b> of the response profile in the process operating range by rotating the response profile around the zero-reference point as a pivot.</p> <p>The Zero-Correct procedure can be done at any time during the Correct LRV and Correct URV procedures in the same calibration session.</p> <p>The Correct LRV and Correct URV procedure should never be performed without first performing the Correct Input (Zero) procedure in the same calibration session.</p>	<p><b>Objective(s):</b></p> <p>Using a precision PV input source as a reference, command the transmitter to write calibration coefficients to Non-Volatile Memory associated with transmitter input hardware and software.</p> <ul style="list-style-type: none"> <li>• Correct Input (Zero)</li> <li>• Correct LRV</li> <li>• Correct URV</li> </ul> 

Input Calibration (DE Transmitters) - Correct Input (Zero), LRV, URV; Reset Corrects														
<p><b>Set-Up On Bench</b></p> <p>A typical bench set-up is shown at right.</p> <p>Connect the MC Toolkit as indicated, and establish communication with the transmitter.</p> <p>For these procedures, components in the current loop are not critical, provided that they support reliable communication between the transmitter and the MC Toolkit.</p> <p>If a Honeywell Pressure Transmitter is being calibrated, positioning (leveling) is important, because the meter body contains fluids that can affect zero sensing.</p>														
<p><b>Enter (configure) values for LRV and URV</b></p>	<p>From the DE MAIN MENU, select <b>Configure</b> to call up the DE CONFIGURE display.</p> <ol style="list-style-type: none"> <li>a. Use the <b>PV Units</b> to select the appropriate Engineering Units.</li> <li>b. Using the keyboard, enter the desired <b>LRV</b> and <b>URV</b> values.</li> <li>c. Select the <b>Send</b> button to copy all newly entered values to the transmitter. When the copy operation is complete, <b>Send</b> will be displayed in half intensity.</li> </ol>	<div style="border: 1px solid black; padding: 5px;"> <p style="text-align: center; margin: 0;">DE CONFIGURE</p> <table style="width: 100%; border-collapse: collapse;"> <tr> <td style="width: 50%;">LRV <input style="width: 50px;" type="text" value="10.0"/></td> <td style="width: 50%;">URL <input style="width: 50px;" type="text" value="10.0"/></td> </tr> <tr> <td>LRV <input style="width: 50px;" type="text" value="0.19371"/></td> <td>URV <input style="width: 50px;" type="text" value="10.194"/></td> </tr> <tr> <td>PV Units <input style="width: 50px;" type="text" value="inH2O @ 39F"/></td> <td>SV Units <input style="width: 50px;" type="text" value="°C"/></td> </tr> <tr> <td>Sensor Type <input style="width: 50px;" type="text" value="DP"/></td> <td>Damping <input style="width: 50px;" type="text" value="32.00"/></td> </tr> <tr> <td>Span <input style="width: 50px;" type="text" value="10.0"/></td> <td>Conformity <input style="width: 50px;" type="text" value="Linear"/></td> </tr> <tr> <td style="text-align: center;"><input type="button" value="Send"/></td> <td style="text-align: center;"><input type="button" value="Back"/></td> </tr> </table> </div>	LRV <input style="width: 50px;" type="text" value="10.0"/>	URL <input style="width: 50px;" type="text" value="10.0"/>	LRV <input style="width: 50px;" type="text" value="0.19371"/>	URV <input style="width: 50px;" type="text" value="10.194"/>	PV Units <input style="width: 50px;" type="text" value="inH2O @ 39F"/>	SV Units <input style="width: 50px;" type="text" value="°C"/>	Sensor Type <input style="width: 50px;" type="text" value="DP"/>	Damping <input style="width: 50px;" type="text" value="32.00"/>	Span <input style="width: 50px;" type="text" value="10.0"/>	Conformity <input style="width: 50px;" type="text" value="Linear"/>	<input type="button" value="Send"/>	<input type="button" value="Back"/>
LRV <input style="width: 50px;" type="text" value="10.0"/>	URL <input style="width: 50px;" type="text" value="10.0"/>													
LRV <input style="width: 50px;" type="text" value="0.19371"/>	URV <input style="width: 50px;" type="text" value="10.194"/>													
PV Units <input style="width: 50px;" type="text" value="inH2O @ 39F"/>	SV Units <input style="width: 50px;" type="text" value="°C"/>													
Sensor Type <input style="width: 50px;" type="text" value="DP"/>	Damping <input style="width: 50px;" type="text" value="32.00"/>													
Span <input style="width: 50px;" type="text" value="10.0"/>	Conformity <input style="width: 50px;" type="text" value="Linear"/>													
<input type="button" value="Send"/>	<input type="button" value="Back"/>													



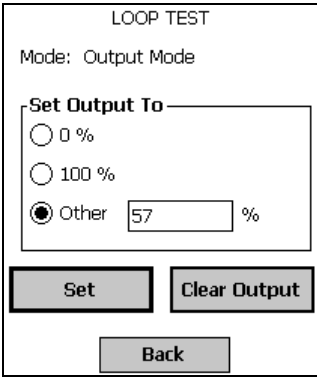
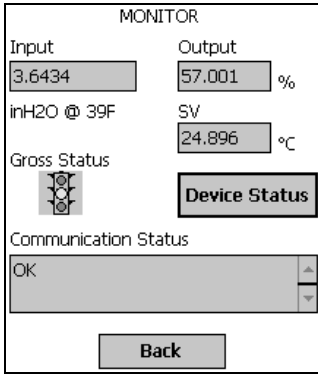

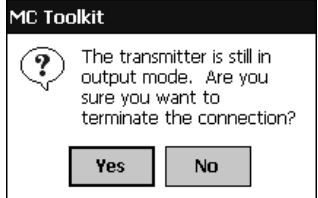
Input Calibration (DE Transmitters) - Correct Input (Zero), LRV, URV; Reset Corrects		
<p><b>Call up Calibration display</b></p>	<p>Navigate to the DE Calibration display as follows.</p> <p>Select <b>Back</b> (go to DE Main Menu), then select the <b>Calibration</b> button.</p>	
<p><b>Correct Input at Zero</b></p>	<p>Select <b>Corr. Input (zero)</b>.</p> <p>This message appears.</p>  <p><b>NOTE:</b>                  The PV Input (Zero) refers to a known standard such as zero pressure (e.g.: vent both sides of a DP transmitter).</p>	<p>As indicated below, this procedure will shift the slope up or down to eliminate the error at the zero reference. The slope (angle) of the response is unchanged.</p> 
	<p>Select <b>Yes</b> in the message box above; this message appears.</p> 	<p>At this point, ensure that the <b>value</b> of the PV applied at the input <b>is exactly Zero</b>.</p> <p>Then, select the <b>OK</b> button in the popup message.</p> <p>This action sends the Correct Input (Zero) command to the transmitter, which adjusts the input calculation.</p>
	<p>Wait until this message appears.</p> 	<p>When the transmitter has completed the Zero Correction, this message appears.</p>  <p>Select the <b>OK</b> button to acknowledge.</p>

Input Calibration (DE Transmitters) - Correct Input (Zero), LRV, URV; Reset Corrects			
<p><b>Correct Input at LRV</b></p> <p>(ST 3000 / ST 800)</p>	<p>Select the <b>Correct LRV</b> button. This message appears.</p>  <p>Adjust the PV input pressure to the <b>exact value of the LRV</b> entered in the DE CONFIGURE display.</p>	<p>Select the <b>OK</b> button; this message appears.</p>  <p>Observe the input pressure at the applied value; when it is stable, select the <b>OK</b> button.</p>	<p>When the transmitter has completed the LRV correction, this message appears.</p>  <p>Select <b>OK</b> to acknowledge.</p>
<p><b>Correct Input at LRV</b></p> <p>(STT 3000)</p>	<p>Select the <b>Correct LRV</b> button. This message appears.</p> 	<p>Adjust the input temperature to the <b>exact value of the LRV</b> entered in the DE CONFIGURE display.</p>	<p>Select the <b>OK</b> button; this message appears.</p>  <p>Select the <b>OK</b> button to acknowledge</p>
<p><b>Correct Input at URV</b></p> <p>(ST 3000 / ST 800)</p>	<p>Select the <b>Correct URV</b> button. This message appears.</p> 	<p>Adjust the PV input pressure to the <b>exact value of the URV</b> entered in the DE CONFIGURE display.</p>  <p>Select the <b>OK</b> button.</p>	<p>When the transmitter has completed the URV correction, this message appears.</p>  <p>Select <b>OK</b> to acknowledge.</p>
<p><b>Correct Input at URV</b></p> <p>(STT 3000)</p>	<p>Select the <b>Correct URV</b> button. This message appears.</p> 	<p>Adjust the input temperature to the <b>exact value of the URV</b> entered in the DE CONFIGURE display.</p>	<p>Select the <b>OK</b> button; this message appears.</p>  <p>Select the <b>OK</b> button to acknowledge</p>

Input Calibration (DE Transmitters) - Correct Input (Zero), LRV, URV; Reset Corrects		
<b>Reset Corrects</b>	<p><b>Note:</b></p> <p>This function commands the transmitter to overwrite all user input corrections with factory default ("characterization") values.</p> <p>It is intended for use only when excessive corrections render the transmitter inaccurate.</p>	 <p>If corrects should not be overwritten with factory values, select the <b>No</b> button.</p> <p>If corrects need to be overwritten, select the <b>Yes</b> button. The timer will appear briefly, indicating the operation is performed.</p>

**Table 15 Output Calibration - Loop Test**

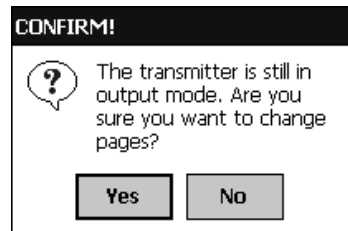
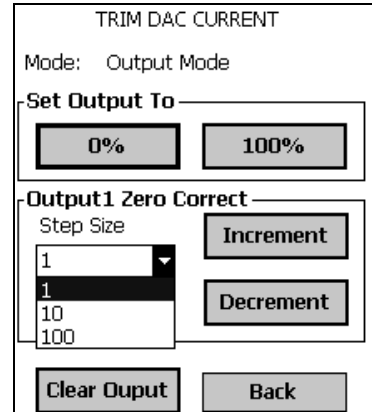
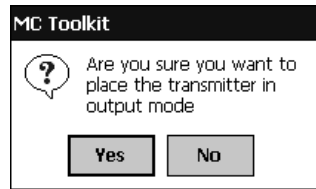
Output Calibration - Loop Test			
<p><b>Objective</b></p> <p>Verify the integrity of electrical components in the output current loop.</p> <p>Connect the MC Toolkit as indicated, and establish communication with the transmitter.</p> <p>For these procedures, values of components in the current loop are not critical, provided that they support reliable communication between the transmitter and the MC Toolkit.</p>			
<p><b>Loop Test</b></p> <p>In the Output Calibration box, select the <b>Loop Test</b> button; the display at right appears.</p> <p>Select the desired constant-level Output: <b>0 %</b>, <b>100 %</b>, or <b>Other</b> (any of <b>0 % - 100 %</b>).</p>	<div style="display: flex; justify-content: space-between;"> <div style="width: 45%;"> </div> <div style="width: 50%;"> <p>Select the <b>Set</b> button.</p> <p>Select the <b>Yes</b> button, and observe the output current at 0%, 100%, or Other (user-entered) %.</p> </div> </div>		
<p><b>Note:</b></p> <p>If the transmitter is in Analog mode, you can observe the output on an externally connected meter or on a Local Meter.</p> <p>In DE Mode, the output can be observed on the Local Meter or on the Monitor display on the MC Toolkit.</p>	<p>To view the Monitor display, navigate <b>Back</b> from the LOOP TEST display and select the MONITOR display.</p> <p>This popup appears; select <b>Yes</b> to continue.</p> <p><b>Example:</b> DE output (100 %), as viewed on the MC Toolkit.</p>		

Output Calibration - Loop Test			
<p><b>Example</b></p>	<p>The displays at right illustrate a <b>Set Output</b> selection and setting of <b>Other</b>, at 57%.</p>		
 <p><b>!!</b>  <b>Unintended exit in Output Mode?</b>  <b>!!</b></p>	<p><b>Caution:</b>          If <b>Yes</b> was selected as above in the <b>CONFIRM!</b> Pop-up message, it is possible to exit MC Toolkit application while the Output is fixed at constant current.</p>	<p>This message at right appears if you perform an operation on the MC Toolkit that will terminate the connection to the transmitter while the transmitter is in output mode.</p>	<p>Select <b>Yes</b> button only if constant-current Output with the MC Toolkit is intended.</p>  <p>Otherwise, select the <b>No</b> button, go back to the LOOP TEST display, and select the <b>Clear Output</b> button.</p>

**Table 16 DE Output Calibration - Trim DAC Current**

DE Output Calibration - Trim DAC Current		
<p><b>Overview of Objectives</b></p>	<p>For a DE transmitter <i>operating in analog mode</i> in a user's application, calibrate the <i>analog output current</i> to the PV input range. That is, adjust the output such that 4 mA corresponds to 0% (LRV), and 20 mA corresponds to 100% (URV).</p>	
<p><b>Call up display</b></p>	<p>In the DE MAIN MENU, select the <b>Calibration</b> button.</p> <p>The CALIBRATION menu appears.</p>	
		<p>Select the <b>Trim DAC Curr.</b> button; this display appears.</p>

DE Output Calibration - Trim DAC Current	
<p><b>Trim Output Current</b></p>	<p>Select the <b>Set Output To 0%</b> button or the <b>100%</b> button. The message popup at right appears.</p> <div style="border: 1px solid black; padding: 5px; margin-bottom: 10px;"> <p><b>Caution:</b>                      In Output Mode, output current is fixed at 0% or 100%. Ensure that the loop is in Manual control.</p> </div> <p>Select the <b>Yes</b> button, and at the meter, observe the level of loop current.</p> <div style="border: 1px solid black; padding: 5px; margin-bottom: 10px;"> <p><b>NOTE:</b>                      On the voltmeter, 4 mA corresponds to 1 volt.</p> </div> <p>Using the MC Toolkit, adjust the loop current to the Zero Percent level (4 mA). If the current is low, tap on the <b>Increment</b> button; if it is high, tap on the <b>Decrement</b> button, and observe the change on the meter.</p> <div style="border: 1px solid black; padding: 5px; margin-bottom: 10px;"> <p><b>NOTE:</b>                      If the error is large, you can accelerate the adjustment rate by changing the Step Size to 10 or to 100.</p> </div> <p>When the zero current level (4 mA) is achieved, select the <b>Set Output To 100 %</b> button.</p> <div style="border: 1px solid black; padding: 5px; margin-bottom: 10px;"> <p><b>NOTE:</b>                      On the voltmeter, 20 mA corresponds to 5 volts.</p> </div> <p>Use the Increment and/or Decrement buttons to adjust the output current to 20 mA.</p> <p>When the 100% current level (20 mA) is achieved, select the <b>Clear Output</b> button. (Note that the button changes to half intensity.)</p>
<p><b>Change display while in Output Mode</b></p>	<p>If you select the <b>Back</b> button before selecting the <b>Clear Output</b> button, the display at right will appear.</p> <p>If you are sure that you want to remain in Output Mode while viewing other displays, select the <b>Yes</b> button; otherwise, select the <b>No</b> button, and the <b>Clear Output</b> button</p>



**Table 17 DE Calibration - Apply Values**

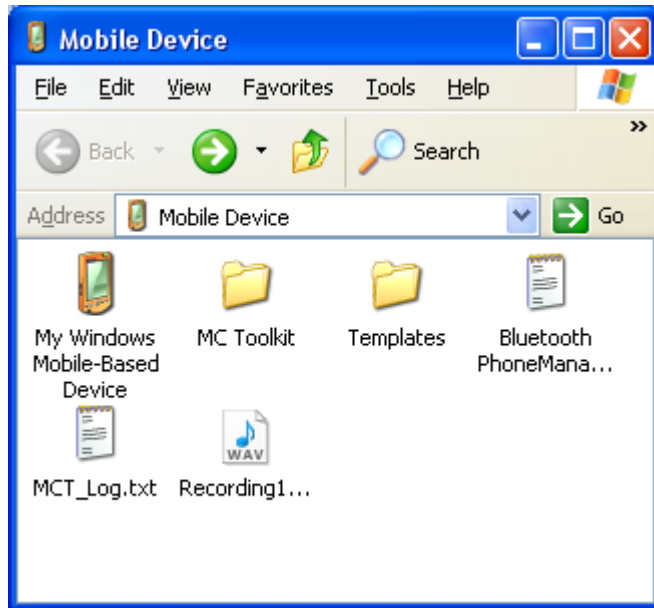
DE Calibration - Apply PV values to Set LRV and Set URV		
<p><b>Overview of Objectives:</b></p> <ul style="list-style-type: none"> <li>Manually set the Process Variable <b>input to 0%</b>, and apply this value to <b>Set LRV</b>;</li> <li>Manually set the Process Variable <b>input to 100%</b>, and apply this value to <b>Set URV</b>.</li> </ul>	<div style="border: 1px solid black; padding: 5px; margin-bottom: 10px;"> <p><b>NOTE:</b> This procedure applies to DE Transmitters operating in DE Mode as well as to those operating in Analog (current) Mode.</p> </div>	
<p>On the DE MAIN MENU, select the <b>Calibration</b> button.</p> <div style="border: 1px solid black; padding: 5px; margin-bottom: 10px;"> <p style="text-align: center;">CALIBRATION</p> <p><b>Input Calibration</b></p> <p>Corr. Input (zero)    Correct LRV</p> <p>Reset Corrects    Correct URV</p> <p><b>Output Calibration</b></p> <p>Loop Test</p> <p>Trim DAC Curr.</p> <p><b>Apply Values</b></p> <p>Set LRV</p> <p>Set URV</p> <p style="text-align: center;">Back</p> </div>	<p>In the Apply Values group, select the <b>Set LRV</b> button.</p> <p>The popup message at right appears.</p> <div style="border: 1px solid black; padding: 5px; margin-bottom: 10px;"> <p><b>Note:</b> The value of the Input indicated in this message updates only when the popup message is called up.</p> </div> <p>To update this value, select the <b>No</b> button, and again select the <b>Set LRV</b> button in the CALIBRATION display.</p>	<div style="border: 1px solid black; padding: 5px;"> <p style="text-align: center;"><b>Set LRV</b></p> <p>LRV = 0.19371 inH2O @ 39F</p> <p>Input = 0.19372 inH2O @ 39F</p> <p>Do you want to set the LRV equal to the Input?</p> <p style="text-align: center;">Yes    No</p> </div>



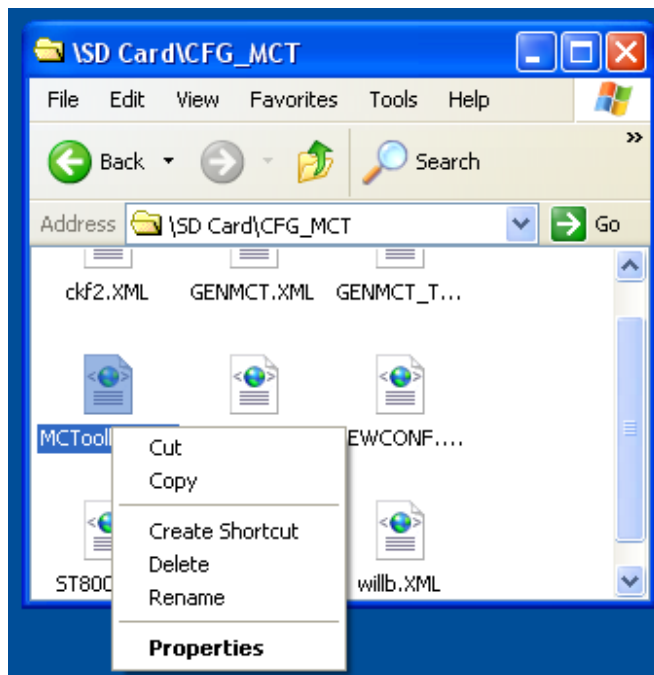
<b>DE Calibration - Apply PV values to Set LRV and Set URV</b>		
<b>Set LRV</b>	<p>While observing the PV value at the physical process element, (using a sight glass, for example) adjust the Process Variable to the desired Minimum (0 %) level, then select <b>Set LRV</b></p> <p>If the displayed value is satisfactory, select <b>Yes</b> to copy the Input Value to the LRV in the transmitter. If not, select <b>NO</b> and repeat this step.</p>	<div style="border: 1px solid black; padding: 5px;"> <p><b>Set LRV</b></p> <p>LRV = 0.19371 inH2O @ 39F                      Input = 0.19372 inH2O @ 39F                      Do you want to set the LRV equal to the Input?</p> <p style="text-align: center;"> <input type="button" value="Yes"/> <input type="button" value="No"/> </p> </div>
<b>Set URV</b>	<p>While observing the PV value at the physical process element, (using a sight glass, for example) adjust the process variable to the desired Maximum level, then select <b>Set URV</b>.</p> <p>If the displayed value is satisfactory, select <b>Yes</b> to copy the Input Value to the URV in the transmitter. If not, select <b>NO</b> and repeat this step.</p>	<div style="border: 1px solid black; padding: 5px;"> <p><b>Set URV</b></p> <p>URV = 10.192 inH2O @ 39F                      Input = 10.54 inH2O @ 39F                      Do you want to set the URV equal to the Input?</p> <p style="text-align: center;"> <input type="button" value="Yes"/> <input type="button" value="No"/> </p> </div>
<b>Verify settings</b>	<p>The results of the Set LRV and Set URV actions can be verified by calling up the <b>DE CONFIGURE</b> display.</p>	<div style="border: 1px solid black; padding: 5px;"> <p style="text-align: center;">DE CONFIGURE</p> <p>LRV <input type="text" value="10.0"/> URL <input type="text" value="10.0"/></p> <p>LRV <input type="text" value="0.19372"/> URV <input type="text" value="10.194"/></p> <p>PV Units <input type="text" value="inH2O @ 39F"/> SV Units <input type="text" value="°C"/></p> <p>Sensor Type <input type="text" value="DP"/> Damping <input type="text" value="32.00"/></p> <p>Span <input type="text" value="10.0"/> Conformity <input type="text" value="Linear"/></p> <p style="text-align: center;"> <input type="button" value="Send"/> <input type="button" value="Back"/> </p> </div>

## 5.6 How to view the Saved Configuration file and Import to Excel

1. Setup Activesync connection between your PC and MC Toolkit
2. Right click on ActiveSync icon on the System tray and select Explore

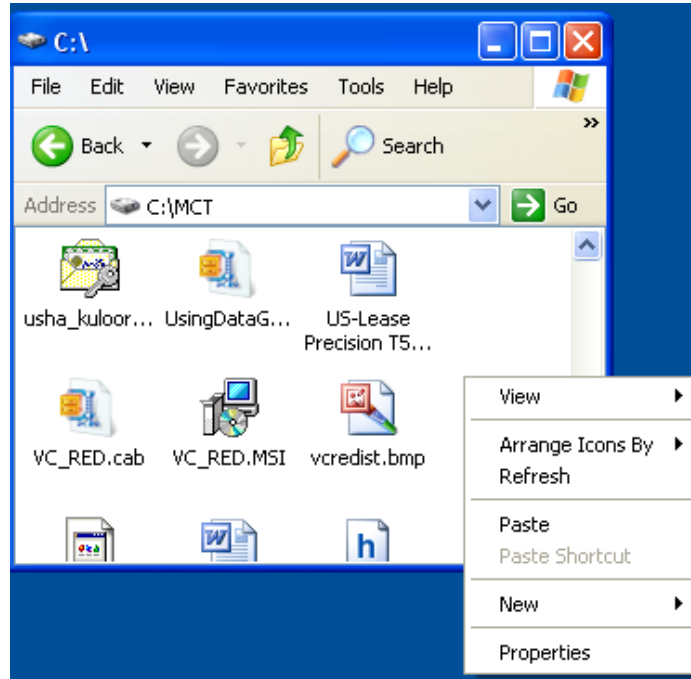


3. Select My Windows Mobile-Based Device\SD Card\CFG\_MCT\\*.XML file that you would like to copy to the PC.



4. Right click on the file and select Copy
5. Go to a location on the PC; for example c:\MCT

6. Right click and select Paste.



Now you can double click on the .xml file to open in the Internet Explorer Browser. The Configurations are shown as below:

```

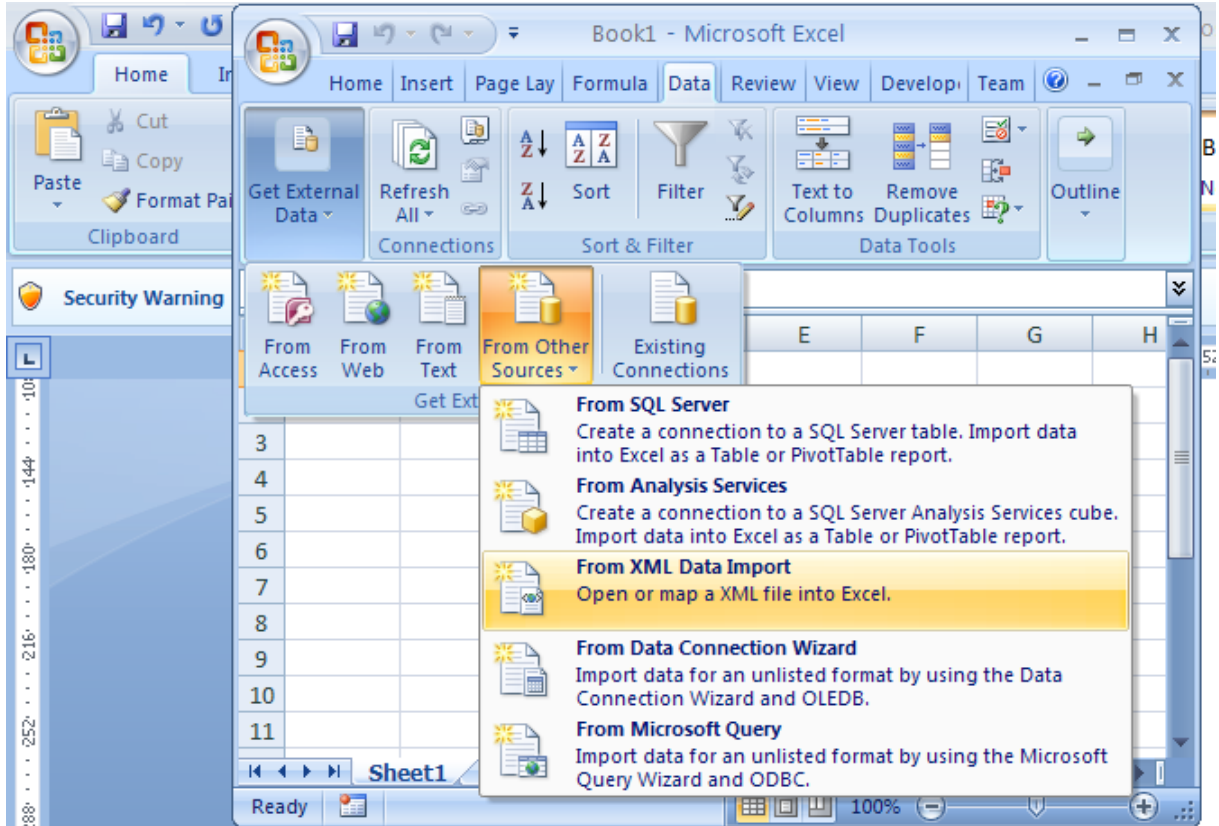
C:\MC Toolkit Installation\MCT_INSTALLFILES\CFG_MCT\MCToolkit.XML - Windows Internet Explorer
C:\MC Toolkit Installation\MCT_INSTALLFILES\CFG_MCT\MCToolkit.XML
File Edit View Favorites Tools Help
Google Search
https://www.honeywellproce... C:\MC Toolkit Installation...
To help protect your security, Internet Explorer has restricted this webpage from running scripts or ActiveX controls that could acc...

- <Database>
- <Table name="Instrument">
- <Record>
  <Field name="Bus Type">Analog</Field>
  <Field name="Device">ST 3000</Field>
  <Field name="Tag ID">Tag23</Field>
  <Field name="Serial Number">4375069400</Field>
  <Field name="Manufacturer">Honeywell</Field>
  <Field name="Model Number">B.6</Field>
  <Field name="Transfer Function">0</Field>
  <Field name="Input Range : In Low">0.0</Field>
  <Field name="Input Range : In High">328.07</Field>
  <Field name="Input Range : In Units">0</Field>
  <Field name="Output Range : Out Low">4.00</Field>
  <Field name="Output Range : Out High">20.00</Field>
  <Field name="Output Range : Out Units">mA</Field>
  <Field name="OEM-DevType">23-ST 3000-S,vB.6-T,v0</Field>
  <Field name="LRL">0.0</Field>
  <Field name="URL">400.0</Field>
  <Field name="Damping">0.00</Field>
  <Field name="SensorType">0</Field>
  <Field name="LineFilter">0</Field>
  <Field name="Scratch">Scratch Test</Field>
  <Field name="LastCfgUpdt">09-20-2007 12:25:25</Field>
  <Field name="DevLRL">0.00000</Field>
  <Field name="DevURL">400.00000</Field>
  <Field name="SVUnit">0</Field>
  <Field name="BreakDet">100</Field>
  <Field name="LatchAlrm">100</Field>
  <Field name="CJComp">100</Field>
  <Field name="DevLRV">0.00000</Field>
  <Field name="DevURV">0.82018</Field>
  <Field name="URLRnge">400.00000</Field>
  <Field name="DESTT250Type">0</Field>
</Record>
- <Record>
  <Field name="Bus Type">Analog</Field>
  <Field name="Device">STT25M</Field>
  <Field name="Tag ID">Tag24</Field>
  <Field name="Serial Number">B125340237</Field>
  <Field name="Manufacturer">Honeywell</Field>

```

## How to Import the data from the xml file to Excel?

1. Open Microsoft Excel



2. Select Data / Get External Data / From Other Sources / From XML Data Import, and Browse to the .xml file you saved on your PC.

This will Import data in the below format.

## 5.6. How to view the Saved Configuration file and Import to Excel

The screenshot shows the Microsoft Excel interface with a table named 'Table1' containing 35 rows of instrument configuration data. The table is displayed in a grid with columns A, B, and C. The ribbon is set to 'Table Tools - Design'.

name	Field	name2
Instrument	Analog	Bus Type
Instrument	ST 3000	Device
Instrument	Tag23	Tag ID
Instrument	4375069400	Serial Number
Instrument	Honeywell	Manufacturer
Instrument	B.6	Model Number
Instrument	0	Transfer Function
Instrument	0.0	Input Range : In Low
Instrument	328.07	Input Range : In High
Instrument	0	Input Range : In Units
Instrument	4.00	Output Range : Out Low
Instrument	20.00	Output Range : Out High
Instrument	mA	Output Range : Out Units
Instrument	23-ST 3000-S,vB.6-T,v0	OEM-DevType
Instrument	0.0	LRL
Instrument	400.0	URL
Instrument	0.00	Damping
Instrument	0	SensorType
Instrument	0	LineFilter
Instrument	Scratch Test	Scratch
Instrument	09-20-2007 12:25:25	LastCfgUpdt
Instrument	0.00000	DevLRL
Instrument	400.00000	DevURL
Instrument	0	SVUnit
Instrument	100	BreakDet
Instrument	100	LatchAlrm
Instrument	100	CJComp
Instrument	0.00000	DevLRV
Instrument	0.82018	DevURV
Instrument	400.00000	URLRnge
Instrument	0	DESTT250Type
Instrument	Analog	Bus Type
Instrument	STT25M	Device
Instrument	Tag24	Tag ID

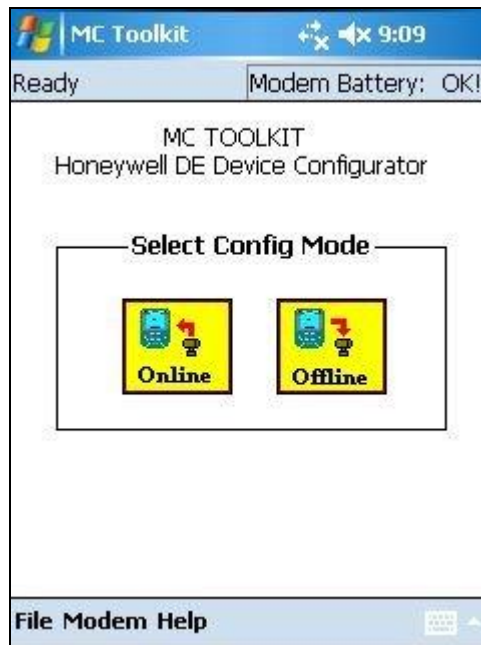
This can be saved as an Excel file for further file management.

## 5.7 Offline Configuration

Using Offline configuration, you can select a basic offline template, edit the parameters and download to a device after establishing connection. The updates to the parameters can also be saved into the file without actually downloading to the device.

### Offline Mode Introduction

On the MC Toolkit Home page select “Offline” to proceed with Offline Configuration features.



Offline configuration supports the following features:

- File Management : Open an XML file, select a saved configuration for the selected device and edit the parameters
- Save to File: Save the parameters back to the file
- Download: Download current Offline configuration to a device after establishing connection.

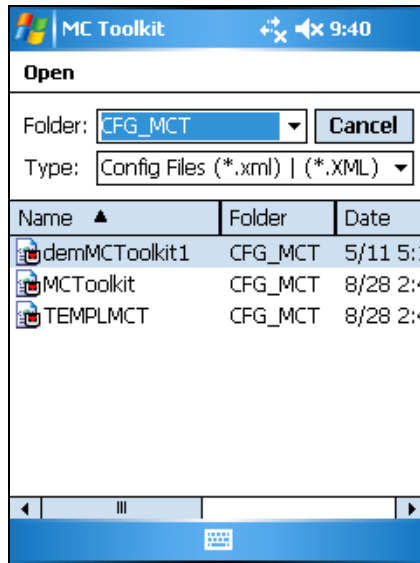
The following devices are supported:

- Honeywell Smart Pressure devices: ST 3000, ST 800
- Honeywell Smart Temperature devices: STT25M, STT25D, STT350)

On the Home page select “Offline” button to proceed with Offline Configuration features.

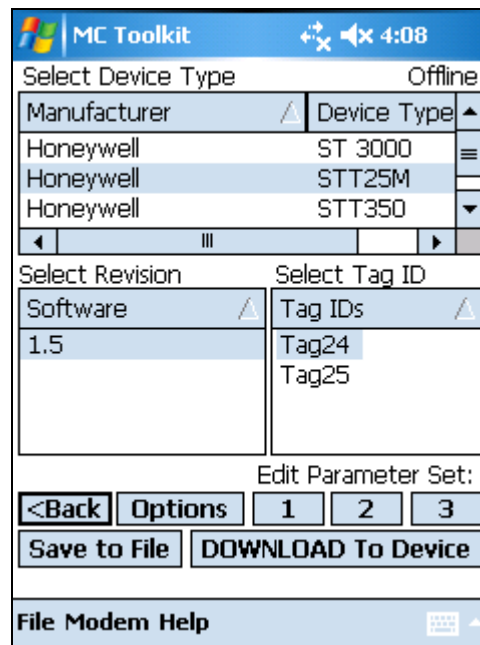
**FILE MANAGEMENT screen**

On the “FILE MANAGEMENT” screen, accept the last file that was accessed or you can select “Browse” to open up the “Open” dialog and browse for a different file that has the offline configurations. MC Toolkit will be shipped with 2 files MCToolkit.xml and TEMPLMCT.xml. The MCToolkit.xml file consists of default configurations for all the supported DE devices. The available configurations can be updated and saved back to this file. The TEMPLMCT.XML is a Template file and you cannot edit the configuration in this file. To read more about the Template file refer the section **Template File**.



**Figure 5-2 Offline Browse / Open File dialog**

The file lists all the configurations available for Honeywell DE devices



**Back button:** takes you back to the File Management screen

**Options button:** Selection of this button opens up the **MC Toolkit Options** dialog

**Edit parameter Set, 1, 2, 3:** Selection of these buttons open up the **Parameters Screens**



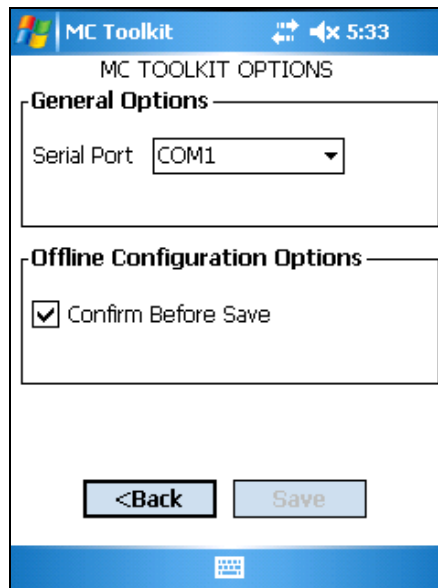
**Save to File:** Allows you to save the changes made to the offline configuration.

**Download to Device:** Allows downloading the selected configuration to the device after establishing connection

### **MC Toolkit Options dialog**

Select the File / Options menu or 'Options' button on the Select Device Type dialog to open up the MC TOOLKIT OPTIONS screen. The menu is available on the MC TOOLKIT screen and all of the File Management screens.

The Options dialog provides General Options and Offline Configuration Options



**Figure 5-3 MC Toolkit Options**

#### **General Options**

Serial Port - allows you to choose from any of the COM1 through COM8 ports. Currently, the Pocket PC supports only the COM1 port. This option is only for future extension.

#### **Offline Configuration Options**

Confirm Before Save - Check this box to prompt a confirmation message "Do you want to save your changes?" before navigating back to the previous screen on the parameters screens. No message will be prompted if the selection box is not checked.

**Parameters screens**

To access the parameters screens select one of the 3 buttons under the “Edit Parameter Set” caption on the Select Device type dialog.

**Parameter set 1**

MC Toolkit 2:42

Bus Type: Analog

Dev Type: STT25M

Tag ID: Tag24

Scratch Pad:  
Scratch Test

Ser Num: B125340237

Model: 1.5

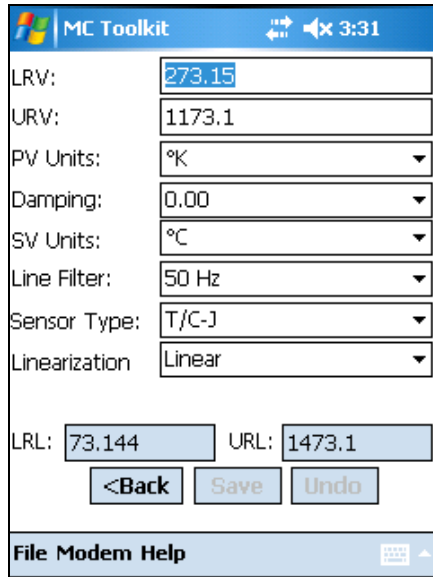
Manufact: Honeywell

<Back Save Undo

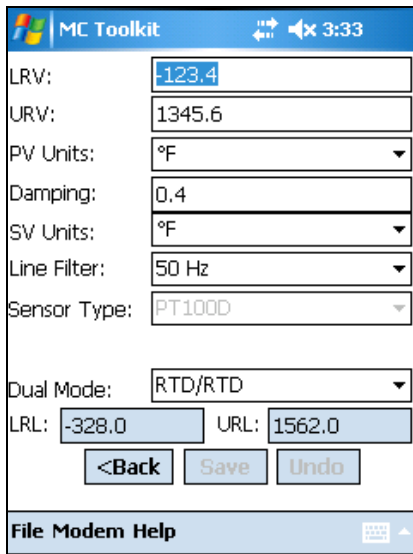
File Modem Help

**Figure 5-4 DE device**

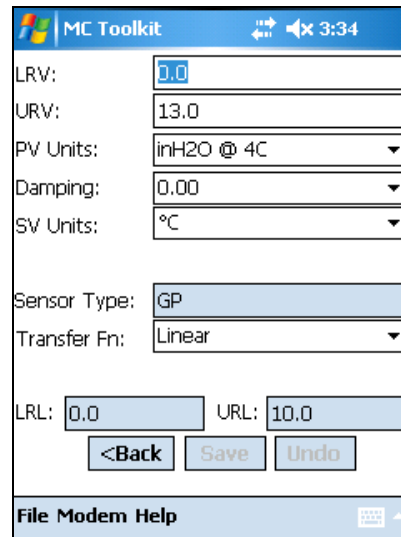
**Parameter set 2**



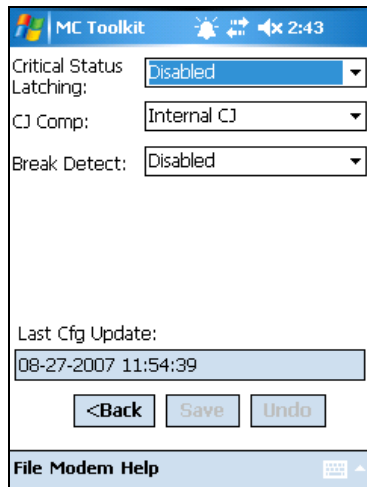
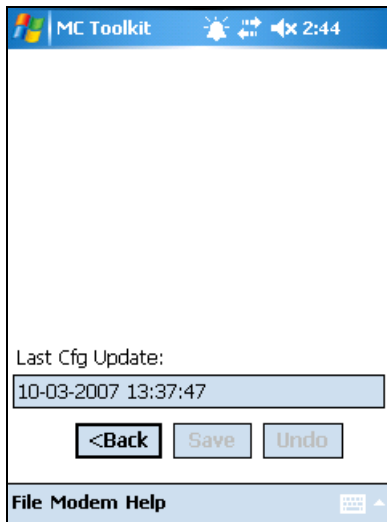
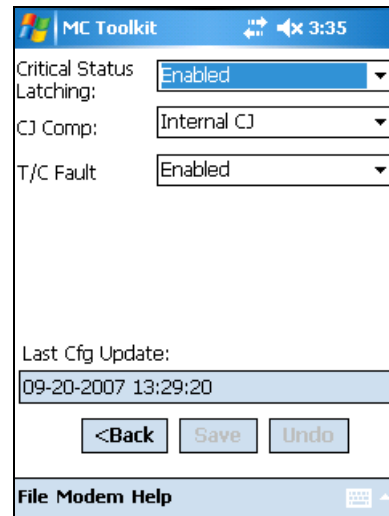
**Figure 5-5 STT25D and 25M, STT350 models**



**Figure 5-6 STT25T model**



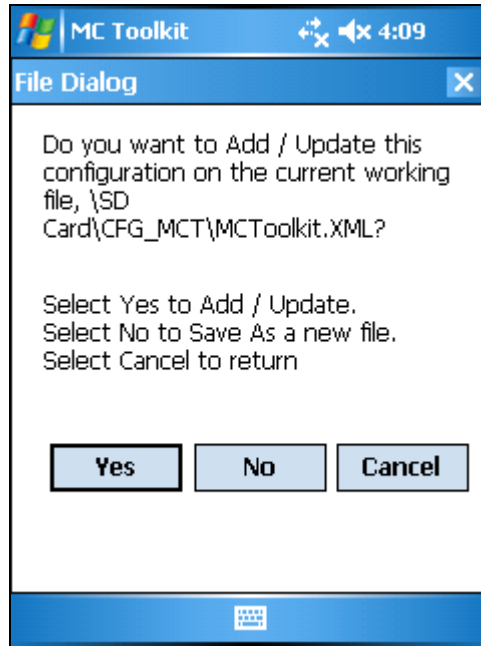
**Figure 5-7 ST 3000 / ST 800 models**

**Parameter set 3****Figure 5-8 STT25M and 25D models****Figure 5-9 ST3000 DE****Figure 5-10 DE STT350**

The following options are available on the parameters screens:

- Select the “Save” button to save the changes to the database.
- Select the “Undo” button to undo the last change. Depending upon the parameter, a group of related parameters will be undone on selecting the “Undo” button. Also depending upon the parameters changed, the “Undo” button will be disabled when the Undo option is not appropriate.
- To go back to the previous screen select the <Back button.

## Save to File in Offline Mode



Selecting Yes adds the current configuration into the current working file.

Selecting No, brings up the “Save As” screen. The location and folder are set to SD Card and CFG\_MCT. You can type in a new name for the file. The default name will be “New1”.

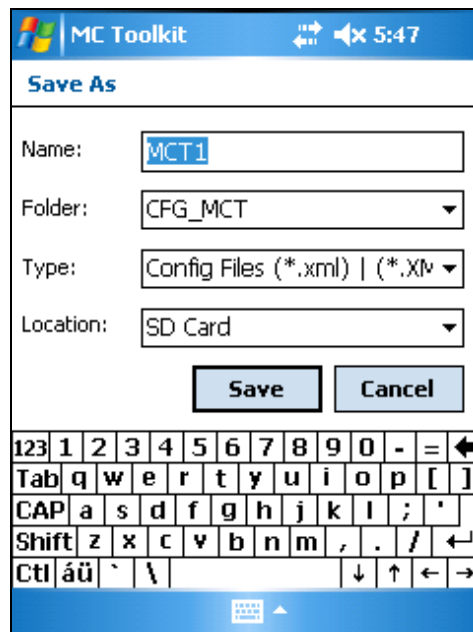
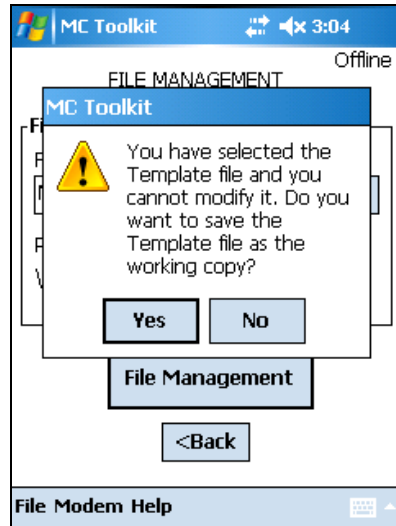


Figure 5-11 Save As File dialog

## Template File

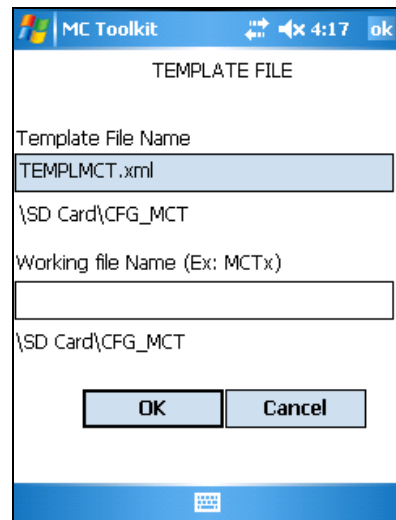
MC Toolkit will be shipped with a template file named TEMPLMCT.XML” with some default configurations. The user cannot modify it.

If the user selects this file for loading and editing parameters, he gets the message shown in Figure 5-12 Honeywell DE Save Template Screen.



**Figure 5-12 Honeywell DE Save Template Screen**

The user can select “Yes” to save the Template file as the working copy by giving a new name other than TEMPLMCT.XML in the screen below



**Figure 5-13 Offline Honeywell DE Save Template as working file**

In the Working File Name field, enter a file name other than TEMPLMCT.XML without any extensions, and then select OK. The newly named file now will be the Working file.

If you select Cancel, you will go back to the FILE MANAGEMENT dialog without any changes.

### Download in Offline mode

Apply power to the device. Connect the PPC to the modem with the serial cable and connect the modem to the device. Select “DOWNLOAD to Device” to establish connection to the device and Download the selected configuration to the connected device. Download confirmation screen will be displayed as in Figure 5-14 Download in Offline Mode.

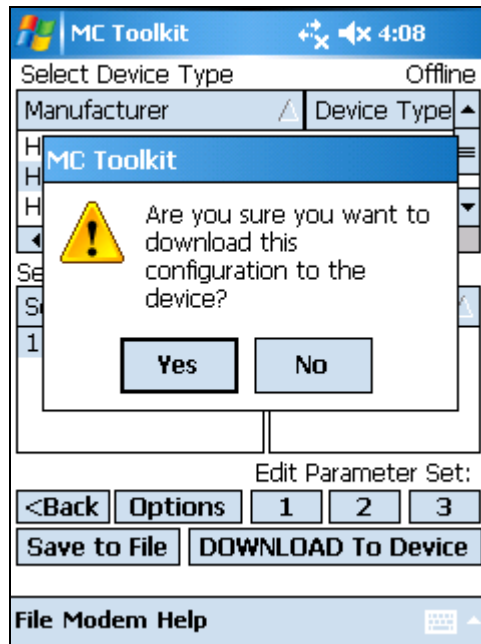


Figure 5-14 Download in Offline Mode

## Download Parameter List

The table below lists all the Parameters available+ in the MC Toolkit offline configuration file

Index (Index of the parameters in the configuration file)	Parameters	Example Values	Properties (R – Read only; R/W – Read / Write)
0	Bus Type	DE	R
1	Device	STT 3000	R
2	Tag ID	STT250Ta	R/W
3	Serial Number	B044929237	R
4	Manufacturer	Honeywell	R
5	Model Number	2.0	R
6	Transfer Function (in ST devices) Linearization in STT devices)	ST: Linear and Square root  STT: Linear and Non-Linear	R/W
7	LRV	36.98	R/W
8	URV	594.63	R/W
9	PV Units	0	R/W
10	Output Range : Out Low	4	R – not displayed on the screen
11	Output Range : Output High	20	R – not displayed on the screen
12	Output Range : Out Units	ma	R – not displayed on the screen
13	OEM-Device Type Code	23-STT25M-S, v1.5-T, v0 (DE)	R – Not Displayed
14	LRL	-200	R
15	URL	850	R
16	Damping	1.0	R/W
17	Sensor Type	T/C-E	R/W (depends upon the device. On Pressure devices, this field is Read only)
18	Line Filter	60 Hz	R/W
19	Scratch Pad	Scratch Test	R/W
20	Last Cfg Update	04/06/2007 13:59:59	R
21			



Index (Index of the parameters in the configuration file)	Parameters	Example Values	Properties (R – Read only; R/W – Read / Write)
	Device LRL (DE)	Float (DE)	R (not displayed)
22	Device URL (DE)	Float (DE)	R (not displayed)
23	SV Units	0	R/W
24	Break Detect	1	R/W(depends upon the device)
25	Critical Status Latching	0	R/W(depends upon the device)
26	CJ Comp	0	R/W(depends upon the device)
27	Device LRV (DE)	float	R (not displayed)
28	Device URV (DE)	Float (DE)	R (not displayed)
29	URL Range (DE)	Float (DE)	R (not displayed)
30	DE STT250 Type (DE)	0  0,1 or 2	R (not displayed)  0-STT350 1-STT250 2-Unknown

**DE Fields and Values**

Field	Value		
Bus Type	Analog - for communication mode of Analog (string) DE – for communication mode of 4 byte or 6 byte DE (String)		
Dev Type	Device Type (string)		
Tag ID	Tag id (8 chars string)		
Ser num	Serial number of transmitter (String)		
Manufact	Manufacturer string		
Model	Model Number of transmitter = Firmware Version (String)		
Transfer Function (Called Conformity in ST, Linearization in STT devices)	Linear or Square Root in ST Linear and Non-Linear in STT		
LRV	Transmitter input low in engineering units (floating point)		
URV	Transmitter input high in engineering units (floating point)		
PV Units (STT only)	°C °F	°R K	
PV Units (ST Only)	inH <sub>2</sub> O @ 39°F inH <sub>2</sub> O @ 68°F MmHg @ 0°C PSI KPa	MPa mBar bar g/cm <sup>2</sup> kg/cm <sup>2</sup>	inHg @ 32°F mmH <sub>2</sub> O @ 4°C mH <sub>2</sub> O @ 4°C ATM inH <sub>2</sub> O @ 60°F
Output Range : Out Low (Not displayed on the parameter screen)	Transmitter output low in percent (floating point)		
Output Range : Out High (Not displayed on the parameter screen)	Transmitter output high in percent (floating point)		
Output Range : Out Units (Not displayed on the parameter screen)	ma (milliamps)		
LRL	Lower Range Limit(Floating point)		
URL	Upper Range Limit(Floating point)		
Damping (STT only) (seconds)	0.00 0.30 0.70 1.50	3.10 6.30 12.70	25.50 51.10 102.30

5. Managing DE Devices using MC Toolkit Software  
 5.7. Offline Configuration

Field	Value		
Damping (ST only) (seconds)	0.00	1.00	8.00
	0.16	2.00	16.0
	0.32	4.00	32.0
	0.48		
Sensor Type (STT only)	T/C J	T/C N	RTD-Cu10
	T/C K	RTD-PT100J	RTD-Cu25
	T/C T	Millivolts	T/C-RH Radiomatic
	T/C S	RTD-PT100D	T/C-W5W26
	T/C R	RTD-PT200	T/C-W3W25
	T/C E	RTD-PT500	Ohms
	T/C B	RTD-Ni500	T/C-NiNiMo
Sensor Type (ST only)	DP	AP	GP
Line Filter (STT only)	50 Hz		
	60 Hz		
Scratch pad	32 chars.		
Last Cfg Update	Time Stamp in Date and Time format (string)		
SV Units	°C		
	°F		
T/C Fault (Detect)	Disable / Enable		
Critical Status Latching	Enable/ Disable		
CJ Comp.	Internal / External		

## 5.8 Reference Data

### Glossary

Item	Definition	Description
Conformity	Response form of sensor.	User selection of PV conversion algorithm: Linear or Square Root
D/A Trim	Digital to Analog Trim	Adjustment to digital-to analog (output) conversion algorithm that aligns minimum and maximum values of scaled digital range to minimum (0%) and maximum (100%) values of analog output.
Damping		Digital algorithm in transmitter MPU that reduces noise in a PV that is generated in the process or induced in transmitter components.
EU	Engineering Units	A standard scale of values, selected by you from a standard set for convenient display and interpretation.
Input		Physical property (e.g., pressure) applied to a sensor  Digital value, calculated in the transmitter, that represents magnitude of the physical input
Local Meter		A device associated with a single transmitter and installed locally (in the transmitter housing) or remotely (in a separate housing) that displays variables sensed or calculated in the transmitter.
Loop Test		(In Analog Mode only) a set of commands from the HHC that causes the transmitter to provide 0% (4 mA) and 100% (20 mA) for testing proper operation of all components of the current loop.
LRL	Lower Range Limit	Minimum value in the useful range of the physical property of a transmitter at which a sensor can operate.
LRV	Lower Range Value	Minimum value in a continuous range of "normal" process values.
Match PV's	Toggle for PV Matching	When On, the value of PV2 is set to the value of PV1.
Meter Units		User-selected scale of values that provides for convenient interpretation of values in the associated transmitter.
Output		Analog or digital value, calculated from the input, that is transferred from the transmitter to a receiver (e.g., process control equipment)
PV	Process Variable	Measured magnitude of a primary physical property such as pressure or temperature.
PV Input		Physical property such as pressure or temperature, applied to an input sensor
PV Units	Process Variable Units	Standard scale of values of a PV, selected by you for convenient display and interpretation.
Sensor Type		Standardized designation of the physical design property of a sensor (e.g., DP, AP for pressure TC, RTD for temperature.)
Span		The continuous range of values in the "normal" operating range of PV values (that is, URV-LRV).
SV	Secondary Variable	A measured physical value of a physical property (e.g., temperature) that relates to the measured primary physical property (e.g., pressure).

Item	Definition	Description
SV Units	Secondary Variable Units	Standard scale of values of an SV, chosen by you for convenient display and interpretation.
URL	Upper Range Limit	Minimum value in the useful range of the physical property of a transmitter sensor can operate.
URV	Upper Range Value	Maximum value in a continuous range of "normal" process values.
SEND		Command from the HHC to copy the values of displayed parameters to either the transmitter to which it is connected, or to (NV? memory) in the HHC.
XS Delta Detection	Toggle for Delta Alarm enabling	If XS Delta Detection is On and the Delta Alarm value is exceeded, the PV output goes to the Failsafe value and a Critical Status message is enunciated.  If Off and the Delta Alarm value is exceeded, the PV output is not affected and a Non-Critical Status message is enunciated.

## Honeywell DE Fields and Values

Dialog	Field	Value			
Device Info	Tag ID	Tag id (8 chars.)			
	Type	Transmitter type			
	Firmware version	Firmware version of the transmitter			
	Serial number	Serial number of transmitter			
	Scratch pad	32 chars.			
General	PV Type	Dual Range (STDC)	Single Range	Single Range w/SV	
	Communication mode	Analog	DE 4 byte	DE 6 byte	
	Failsafe Direction	Upscale	Downscale		
	Line Filter (STT only)	50 Hz	60 Hz		
	T/C Fault Detect (STT only)	Enabled	Disabled		
DE Configure	LRL, URL, LRV, URV	Floating point			
	PV Units (STT only)	°C °F	K	°R	
	PV Units (ST only)	inH <sub>2</sub> O @ 39°F inH <sub>2</sub> O @ 68°F MmHg @ 0°C Psi KPa	MPa mBar bar g/cm <sup>2</sup> kg/cm <sup>2</sup>	inHg @ 32°F mmH <sub>2</sub> O @ 4°C mH <sub>2</sub> O @ 4°C ATM inH <sub>2</sub> O @ 60°F	
	SV Units	°C	°F		
	Sensor Type (STT only)	T/C J	T/C N	RTD-Cu10	
		T/C K	RTD-PT100J	RTD-Cu25	
		T/C T	Millivolts	T/C-RH Radiamatic	
		T/C S	RTD-PT100D	T/C-W5W26	
T/C R		RTD-PT200	T/C-W3W25		
T/C E		RTD-PT500	Ohms		
T/C B		RTD-Ni500	T/C-NiNiMo		
Sensor Type (ST only)	DP	AP	GP		
Damping (STT only) (seconds)	0.00	3.10	25.50		
	0.30	6.30	51.10		
	0.70	12.70	102.30		
	1.50				

Dialog	Field	Value		
DE Configure (continued)	Damping (ST only) (seconds)	0.00	1.00	8.00
		0.16	2.00	16.0
		0.32	4.00	32.0
		0.48		
	Span	Floating point	(URV – LRV)	
	Linearization (STT only)	Linear	Non-Linear	
	Conformity (ST only)	Linear	Square Root	
Auxiliary Configure (STT only)	Critical Status Latching	Enabled	Disabled	
	NAMUR	Enabled	Disabled	
	CJ Compensation	Internal	External	
	CJ Temperature	Floating point		
	Write Protection	Enabled	Disabled	
	Password	Write protection password (4 digits)		
Change Password (STT only)	New Password	4 digits		
	Confirm New Password	4 digits		
Monitor	Input	Transmitter input in engineering units (floating point)		
	Output	Transmitter output in percent (floating point)		
	SV	Secondary variable (floating point)		
Device Status	Gross Status	Critical	Non-Critical	Invalid Database
	Critical	Critical status strings		
	Non-Critical	Non-critical status strings		
Local Meter (ST 3000)	Meter Hardware	Full Functional Meter  Meter, NO Local Span or Zero	No Meter, Local Span & Zero	No Meter Installed
	Meter Units	% inH <sub>2</sub> O @ 39°F mmHg @ 0°C psi KPa MPa	mBar bar g/cm <sup>2</sup> kg/cm <sup>2</sup> mmH <sub>2</sub> O @ 4°C	mHg @ 0C mH <sub>2</sub> O 4°C GPM GPH Custom

Dialog	Field	Value		
Local Display (ST 800)	Display Hardware	Display Installed, Display Not detected		
	Display Units	% inH <sub>2</sub> O @ 39°F mmHg @ 0°C psi KPa MPa	mBar bar g/cm <sup>2</sup> kg/cm <sup>2</sup> mmH <sub>2</sub> O @ 4°C	mHg @ 0C mH <sub>2</sub> O 4°C GPM GPH Custom
	Custom Units	8 characters		
	Flow EU Upper Value	Floating point		
	Flow EU Lower Value	Floating point		
	Dialog	Field	Value	
Local Display (STT 850 /STT 750)	Display Type	<ul style="list-style-type: none"> <li>• Not Connected</li> <li>• Advance Display (STT850 only)</li> <li>• Basic Display</li> </ul>		
	Input Model (Sensor Input)	<ul style="list-style-type: none"> <li>• Single input</li> <li>• Dual input</li> </ul>		
	Loop Mode (Sensor Mode)	<ul style="list-style-type: none"> <li>• Sensor 1</li> <li>• Redundant Mode</li> <li>• Delta Mode</li> </ul>		
	Screen Format	View display format: <ul style="list-style-type: none"> <li>• None</li> <li>• Large PV</li> <li>• Bar Graph (Applicable for only Advance Display, STT850 only)</li> <li>• Horizontal Trend (Applicable for only Advance Display, STT850 only)</li> </ul>		
	PV Selection	For Dual input Models: <ul style="list-style-type: none"> <li>• Loop PV (C,F,R,K,Ohm,MV)</li> <li>• CJ Temperature (C,F,R,K)</li> <li>• Sensor 1 (C,F,R,K,Ohm,MV)</li> <li>• Sensor 2 (C,F,R,K)</li> <li>• Sensor Delta (C,F,R,K)</li> <li>• Sensor 1 Resistance (Ohm)</li> <li>• Sensor 2 Resistance (Ohm)</li> <li>• Loop Output (mA)</li> <li>• Percent Output (%)</li> </ul>		



Dialog	Field	Value
Local Display (STT850) <i>Continued ..</i>		For Single Input Models: <ul style="list-style-type: none"> <li>• Loop PV</li> <li>• CJ Temperature</li> <li>• Sensor</li> <li>• Sensor Resistance</li> <li>• Loop Output (mA)</li> <li>• Percent Output</li> </ul>
	Screen Units	Engineering units code. <ul style="list-style-type: none"> <li>• degC</li> <li>• degF</li> <li>• Rankine</li> <li>• Kelvin</li> <li>• Millivolt</li> <li>• Ohm</li> <li>• Percent</li> <li>• Milliamps</li> </ul>
	Decimals	Number of digits to display after the decimal point.  (x, x.x, x.xx, x.xxx)
	Display Lo Lim (STT850 only)	Display Low Limit for Trend / Bar Graph - usually equal to LRV  Floating point value
	Display H Lim (STT850 only)	Display High Limit for Trend, Bar Graph - Usually equal to URV  Floating point value
	Trend Duration (Optional) (STT850 only)	Duration of the trend screen in hours.  Valid range 1 – 999
	Scrn Rotation	<b>Disable or Enable Screen Rotation</b>  Options: <ul style="list-style-type: none"> <li>• Disable</li> <li>• Enable</li> </ul>
	Rotation Time	<b>This sets the Screen ON for the set number of seconds.</b>  <b>3 to 30 seconds</b>

## STT850 / STT750 Local Display Screen1 Configuration using MCT404

This section describes how to configure Honeywell SmartLine Temperature Transmitter - Local Display Screen1 using the MCT404 MCToolkit application. Note that using MCT404 you can configure only one Screen, Screen1

### Configuring Display Screen1 parameters

From the DE Main Menu screen, select Local Display tab. Screen1 configurations are displayed.

After the current Screen parameters are read, you can edit the Screen Format and other parameters one by one, and click Send to write the configurations to the device

Depending on the Display type, Sensor Input mode and Screen Format, some displayed parameters may not be available for configuration and are disabled as listed in Table 3

### Configuring Display Common Parameters

There are two common parameters that are currently configurable: Scrn Rotation (Screen Rotation), Rotation Time.

If any of these 2 parameters are changed, these parameters will be sent to the device first followed by the Screen parameters if any of those Screen parameters are changed. If only the Screen parameters are changed, but not the Common parameters, then only Screen parameters are written to the device

This section describes how to configure Honeywell SmartLine Temperature Transmitter - Local Display Screen1 using the MCT404 MCToolkit application. Note that using MCT404 you can configure only one Screen, Screen1

### Display Screen1 parameter configuration - Example

The screenshot shows the MC Toolkit interface for configuring Display Screen1. The parameters are as follows:

Display Type	Advanced
Input Model	Dual Input
Loop Mode	Redundant
Screen Format	Bar Graph
PV Selection	Sensor 2
Units	°C
Decimals	x.x
Trend Duration	8 hrs
Display Lo Lim	10.0
Display Hi Lim	40.0
Rotation Time	
Scrn Rotation	Disable

Buttons: < Back, Send

File Modem Device Help

Example shows the Connected Display Type is Advanced Display, Input Type is Dual Input, and Loop Mode is Redundant

**Note:** all the above parameters are Read only as these are not user configurable configurations.

### Screen Format:

Select any of the available options for Advanced Display type: In this Example, Bar Graph is selected.

- None
- Large PV
- Bar Graph
- Horizontal Trend

If there is only one screen configured on the Local Display, selecting screen format to None from the Tool will display “No screens configured” on the Local Display.

If there are multiple screens configured, and Screen Rotation is Enabled, then selecting Screen format to None will remove the currently active ScreenX from the Rotation. Other screens will keep rotating at the interval of Screen Rotation time.

If there are multiple screens configured, and Screen Rotation is Disabled, then selecting Screen format to None will remove the currently active ScreenX and will bring Screen(X-1) as the active screen.

#### **PV Selection and Units:**

Select any of the PV Selection options for Dual input mode with the available Units options:

- Loop PV (C,F,R,K,Ohm,MV)
- CJ Temperature (C,F,R,K)
- Sensor 1 (C,F,R,K,Ohm,MV)
- Sensor 2 (C,F,R,K)
- Sensor Delta (C,F,R,K)
- Sensor 1 Resistance (Ohm)
- Sensor 2 Resistance (Ohm)
- Loop Output (mA)
- Percent Output (%)

#### **Decimals:**

Select the number of decimal places for the values that will be displayed on Screen1 for the selected PV:

- X
- X.X
- X.XX
- X.XXX

#### **Trend Duration:**

This is applicable only when PV Format is Trend. Example uses the PV format as Bar Graph, So Trend Duration is disabled.

**Display Lo Lim:** Applicable to Trend, Bar Graph on Advanced Display. Usually this is set equal to LRV

**Display Hi Lim:** Applicable to Trend, Bar Graph on Advanced Display. Usually this is set equal to URV

**Screen Rotation:**

Select Disable to disable the formatted screens from rotating

Select Enable to Enable the rotations.

Note that if the display has multiple Screens configured by using the local buttons on the display, selecting Disable will make the currently active ScreenX to stay as your top screen.

When the Screen1 is configured from MCT404, to see the Screen1 with the changes, user needs to Enable the rotation.

**Screen Rotation Time:**

Select value of 3 to 30 seconds for the formatted screens to rotate. Note that if there is any diagnostics, then the diagnostics will alternately show along with the x number of Screens in Rotation.

## 5.9 XML Database (Samples)

```
<Database>
<Table name="Instrument">
<Record>
<Field name="Bus Type">Analog</Field>
<Field name="Device">ST 3000</Field>
<Field name="Tag ID">Tag23</Field>
<Field name="Serial Number">4375069400</Field>
<Field name="Manufacturer">Honeywell</Field>
<Field name="Model Number">B.6</Field>
<Field name="Transfer Function">0</Field>
<Field name="Input Range : In Low">0.0</Field>
<Field name="Input Range : In High">328.07</Field>
<Field name="Input Range : In Units">0</Field>
<Field name="Output Range : Out Low">4.00</Field>
<Field name="Output Range : Out High">20.00</Field>
<Field name="Output Range : Out Units">mA</Field>
<Field name="OEM-DevType">23-ST 3000-S,vB.6-T,v0</Field>
<Field name="LRL">0.0</Field>
<Field name="URL">400.0</Field>
<Field name="Damping">0.00</Field>
<Field name="SensorType">0</Field>
<Field name="LineFilter">0</Field>
<Field name="Scratch">Scratch Test</Field>
<Field name="LastCfgUpdt">09-20-2007 12:25:25</Field>
<Field name="DevLRL">0.00000</Field>
<Field name="DevURL">400.00000</Field>
<Field name="SVUnit">0</Field>
<Field name="BreakDet">100</Field>
<Field name="LatchAlrm">100</Field>
<Field name="CJComp">100</Field>
```

```
<Field name="DevLRV">0.00000</Field>
<Field name="DevURV">0.82018</Field>
<Field name="URLRnge">400.00000</Field>
<Field name="DESTT250Type">0</Field>
</Record>
</Table>
</Database>
```

The Field names are explained in section [“\*\*Download Parameter List\*\*”](#)

## 6. Troubleshooting

### 6.1 MC Toolkit troubleshooting scenarios

#### MCT404

##### *Start up scenario*

<b>Problem</b>	No DE/HART Modem detected
<b>Cause</b>	The cause may be any one of the following: <ul style="list-style-type: none"><li>• MCT404 battery charge is low</li></ul>
<b>Resolution</b>	You can resolve by performing the following: <ul style="list-style-type: none"><li>• Refer the Battery Care section</li></ul>

## 6.2 FDC application software troubleshooting scenarios

### Application Startup

<b>Problem</b>	Unable to launch or open FDC application.
<b>Cause</b>	The cause may be any one of the following: <ul style="list-style-type: none"> <li>• .NET CF 3.5 is not installed.</li> <li>• FDC is installed in device memory instead of SD card.</li> <li>• One or more dependent files are corrupt.</li> </ul>
<b>Resolution</b>	You can resolve by performing the following: <ul style="list-style-type: none"> <li>• Installing .NET CF 3.5.</li> <li>• Re-installing FDC in SD card.</li> </ul>

### DD Library

<b>Problem</b>	File does not exist is displayed while attempting to delete a DD file
<b>Cause</b>	After manual manipulation of the DD library, the library information is not synchronized with the application
<b>Resolution</b>	You can resolve by performing the following: <ul style="list-style-type: none"> <li>• Open the DD manager and perform Refresh DD Library operation. This will synchronize the DD library.</li> </ul>

### Device identification

<b>Problem</b>	When you tap Online Configuration option, the application displays "Device identification failed..." message and returns to home page.
<b>Cause</b>	The cause may be any one of the following: <ul style="list-style-type: none"> <li>• By default, the application is configured to scan the device with specific poll address. If the connected device has different poll address, then application displays detection failed message.</li> <li>• Problem in device connections.</li> <li>• If the connected device is not HART compliant. For example, if the MC Toolkit is connected to HART DE devices, device detection fails and application displays error message and returns to home page.</li> </ul>
<b>Resolution</b>	You can resolve by performing the following: <ul style="list-style-type: none"> <li>• Configure the Device Detection settings, if the device has different poll address.</li> <li>• Confirm that the device connections are proper.</li> <li>• Confirm that the connected device is HART compliant.</li> </ul>

<b>Problem</b>	Detection at poll address 63 in case of detection by poll
----------------	---



	address using range (0-63) failed sometimes
<b>Cause</b>	Potential issue with the modem
<b>Resolution</b>	You can resolve by performing the following: <ul style="list-style-type: none"> <li>• Retry</li> <li>• Reduce the poll address ranges and try detecting the device</li> </ul>

### Write parameter

<b>Problem</b>	Sometimes it is observed that Send status in download screen may display failure but actually written to the device.
<b>Cause</b>	Failed to update the Send status
<b>Resolution</b>	You can resolve by performing the following: <ul style="list-style-type: none"> <li>• Select the failed items from download screen and retry the send operation</li> </ul>

### Method Execution

<b>Problem</b>	**** Internal Error: **** This method has some constructs which are not supported
<b>Cause</b>	The cause may be any one of the following: <ul style="list-style-type: none"> <li>• Some internal error</li> <li>• Method code has some error</li> <li>• FDC encountered some construct that's not supported</li> </ul>
<b>Resolution</b>	Retry executing the method. If the problem persists, please contact Honeywell TAC

### Graphs and Trends

<b>Problem</b>	Sometimes, on selecting another waveform or variable, Invalid data may be displayed or FDC may not respond.
<b>Cause</b>	The cause may be any one of the following: <ul style="list-style-type: none"> <li>• Failure in communication</li> <li>• One or more action methods associated with trends would have failed.</li> </ul>
<b>Resolution</b>	You can resolve by performing the following: <ul style="list-style-type: none"> <li>• Close the graph/ trend and retry opening again</li> <li>• Or close and reload the device and retry open the graph/ trend again.</li> </ul>
<b>Problem</b>	Sometimes the curves in the graphs may not appear as expected.

<b>Cause</b>	FDC has limits on the number of data points it supports for waveforms on Graphs
<b>Resolution</b>	known limitation

### Save History

<b>Problem</b>	Save history operation may fail in specific scenarios.
<b>Cause</b>	The cause may be any one of the following: <ul style="list-style-type: none"><li>• Communication failure</li><li>• Application might have run out of memory</li><li>• Device specific issue</li></ul>
<b>Resolution</b>	Retry the operation. If the problem persists, please contact Honeywell TAC

### Custom Views

<b>Problem</b>	Variables configured under custom view are not visible when the view opened
<b>Cause</b>	Variables are not valid in the device at that instance of time
<b>Resolution</b>	This is the expected behavior as per the standard

### Close device

<b>Problem</b>	Application shows error message while closing the device screen. It is rarely observed scenario
<b>Cause</b>	The cause may be any one of the following: Application might have run out of memory
<b>Resolution</b>	There is no impact of this error on further device operation. User can proceed with other device operation.

### Offline download

<b>Problem</b>	Offline download may fail for some parameters with 'Send command failed or invalid' message
<b>Cause</b>	The cause may be any one of the following: <ul style="list-style-type: none"><li>• Send command failure</li><li>• Potential issue with communication</li></ul>
<b>Resolution</b>	You can resolve by performing the following: <ul style="list-style-type: none"><li>• Retry offline download for failed items.</li></ul>

<b>Problem</b>	Manufacturer and Device Type name may not be displayed for
----------------	--

	a certain scenarios.
<b>Cause</b>	The cause may be any one of the following: <ul style="list-style-type: none"> <li>• DD file for the device is missing in FDC library</li> </ul>
<b>Resolution</b>	Add appropriate DD file

**Interoperability with FDM**

<b>Problem</b>	Date fields show incorrect date after importing history record to FDM
<b>Cause</b>	Regional settings is mismatch
<b>Resolution</b>	Change the regional setting to English (United states) in FDC PDA and in FDM machine. Then retry saving history again in FDC and re importing in FDM

## 6.3 MC Toolkit application software troubleshooting scenarios

### *Login scenario*

<b>Problem</b>	Unable to launch or open MC Toolkit application.
<b>Cause</b>	The cause may be any one of the following: <ul style="list-style-type: none"><li>• MC Toolkit is installed in device memory instead of SD card.</li><li>• One or more dependent files are corrupt.</li></ul>
<b>Resolution</b>	You can resolve by performing the following: <ul style="list-style-type: none"><li>• Re-installing MC Toolkit in SD card.</li></ul>

### *Launching Help*

<b>Problem</b>	Unable to launch MC Toolkit Help.
<b>Cause</b>	The cause may be any one of the following: <ul style="list-style-type: none"><li>• MC Toolkit application along with the Help files are installed in device memory instead of SD card.</li><li>• One or more dependent files are corrupt.</li></ul>
<b>Resolution</b>	You can resolve by performing the following: <ul style="list-style-type: none"><li>• Re-installing MC Toolkit in SD card.</li></ul>

## MC TOOLKIT ERROR MESSAGES

MESSAGE	Description	Resolution / CORRECTIVE ACTION
Checksum error on Modem Response!	Erroneous data packet received at the modem	A noisy environment can cause this error. Repeat the command again.
Com Port Read Timeout!	Error associated with the Communication port	Ensure that the Honeywell supplied modem cable is used and that the connections are secure.  Make sure the modem has a good battery.
Com read Error!	Error associated with the Communication port	Make sure ActiveSync/Mobile Device Center is not running.
Error writing to Com Port!	Error associated with the Communication port	If several programs are active, try closing one or more open programs.
Error writing to Com Port!	Error associated with the Communication port	Stop the MC Toolkit application by doing File   Exit and restart the program.
EscapeCom function Error!	Error associated with the Communication port	Use the Pocket PC hardware reset. See your Pocket PC documentation reset the unit.
GetCommState Error!	Error associated with the Communication port	
Host Failed to get good response from the Modem!	Error associated with the Communication port	Make sure the modem has a good battery.
Invalid Command number from the Modem!	Error associated with the Communication port	Communications problem between the Pocket PC and the modem. Repeat the command again.
Invalid Handle Value!	Error associated with the Communication port	Make sure ActiveSync/Mobile Device Center is not running.  If Several programs are active, try closing one or more open programs.  Stop the MC Toolkit application by doing File   Exit and restart the program.  Use the Pocket PC hardware reset. See your Pocket PC documentation reset the unit.  Make sure you are using a Honeywell approved Pocket PC.

<b>MESSAGE</b>	<b>Description</b>	<b>Resolution / CORRECTIVE ACTION</b>
Memory Error	Host Pocket PC does not have enough memory to run the program	<p>If several programs are active, try closing one or more open programs.</p> <p>Too many programs installed in the Pocket PC. Check the Pocket PC free memory. Uninstall programs if need to release memory.</p> <p>Too many data files in the Pocket PC. Check the Pocket PC free memory. Delete unused data files to release memory.</p> <p>Use the Pocket PC hardware reset. See your Pocket PC documentation reset the unit.</p>
Message length is longer than expected	Communication interruptions between Host Pocket PC and the modem	<p>Communications problem between the Pocket PC computer and the modem. Repeat the command again.</p>
Message length is shorter than expected	Communication interruptions between Host Pocket PC and the modem	
Modem bad checksum	Erroneous data packet received at the modem	<p>This could indicate a defective modem. Repeat the command again. If the problem persist contact Honeywell TAC.</p>
Modem Buffer overflow	Data bytes from Host Pocket PC to modem is more than expected	<p>Communications problem between the Pocket PC computer and the modem. Repeat the command again.</p>
Modem busy	Command request to the modem is faster than expected	
Modem framing error	Erroneous data packet received at the modem	
Modem illegal command	Unexpected command sent to modem	
Modem illegal data	Unexpected data sent to modem	
Modem network error	Data transmission error between the Host Pocket PC and the modem	
Modem Transmitter Serial Error!	Data transmission error between the Host Pocket PC and the modem	

6. Troubleshooting

6.3. MC Toolkit application software troubleshooting scenarios

MESSAGE	Description	Resolution / CORRECTIVE ACTION
No Response from the Transmitter	Unable to get any data from the Transmitter	<p>Make sure that the MC Toolkit field connections are connected to the transmitter.</p> <p>Verify the transmitter is wired correctly and that it is powered.</p> <p>If connected to a DE transmitter, make sure the polarity of the cables connecting to the transmitter is correct.</p> <p>If connected to a HART transmitter, make sure the address number is correct.</p> <p>Make sure the correct protocol for the transmitter is selected.</p> <p>A defective transmitter can also cause this error message.</p> <p>Verify that a 250 ohm resistor in series with the transmitter.</p>
Resume Monitor Thread Failed!	Host Pocket PC OS error associated with the Threads	<p>Close all the other running applications.</p> <p>Restart MC Toolkit application.</p>
Serial Port is not Available	Some other application is using the serial port	<p>Make sure ActiveSync/Mobile Device Center is not running.</p>
SetCommMask Error!	Error associated with the Communication port	<p>If Several programs are active, try closing one or more open programs.</p>
SetCommState Error!	Error associated with the Communication port	<p>Stop the MC Toolkit application by doing File   Exit and restart the program.</p>
SetCommTimeouts Error!	Error associated with the Communication port	<p>Use the Pocket PC hardware reset. See your Pocket PC documentation reset the unit. Caution: If the Symbol PPT 2800 computer is reset, it will lose all its installed programs and data. The program will have to be installed again.</p> <p>Make sure you are using a Honeywell approved Pocket PC.</p>
Suspend monitor Thread Failed! Upload Cannot Continue.	Host Pocket PC OS error associated with the Threads	<p>System failed to suspend the monitor function</p>
Too Many bytes received on ComPort!		<p>Repeat the command. If the problem persist contact Honeywell TAC.</p>
Transmitter-Modem Receive Buffer overflow!	Data bytes from the transmitter to the modem is more than expected	<p>This could be the result of having older version of the modem. Upgrade the modem firmware using ModemCodeDownload program</p>
Unknown Error!	Unexpected error	

### 6.3. MC Toolkit application software troubleshooting scenarios

---

<b>MESSAGE</b>	<b>Description</b>	<b>Resolution / CORRECTIVE ACTION</b>
COM Port Initialization Failed	Could not initialize the com port	
No HARTDE Modem Present	Could not recognize the presence of the modem	
HARTDE Modem Protocol set failed	Host pocket PC to Modem communication failed	
Error In Communication with Device, Closing the Device.		
No Device found, Do You want to Retry	Could not establish connection to a transmitter	If the above things are perfect, try to change different device detection options from Preference dialog box under Device/Preferences menu, restart the FDC.



## DE Device error messages

MESSAGE	Description	Resolution / CORRECTIVE ACTION
Write NVM Failed	Write to transmitter Non-Volatile Memory failed.	Try the operation again, the transmitter was busy doing something else
Unknown Device	MC Toolkit does not support this transmitter.	Check the list of supported devices
Invalid Range	User-entered value is too high or too low.	Enter value within Range
Invalid Request	This transmitter does not support the command requested.	Check the respective device User Manual for supported operations
NACK	MC Toolkit sensed Non-Acknowledgement of message to the Transmitter.	Try the action again
Illegal Operation	Typically caused by an invalid parameter or an attempt to perform an operation in a mode not allowed by the transmitter.	Do not perform this action as it is illegal
Transmitter in Local Mode	Transmitter in Factory Mode	User is not allowed to perform this operation as it is factory only operation
Transmitter is Busy	Transmitter was communicating when MC Toolkit sent message to transmitter.	Retry the action again
Invalid operation on Write Protected Field	Attempt to write to a protected field.	Remove the Write protection if you are the authorized person by providing the right password and disabling the Write Protect mode
Undefined Gross Status Byte from the Transmitter	The transmitter has reported a status indication not understood by MC Toolkit.	Retry the operation, maybe some disturbance or noise caused unexpected byte on the communication line
Gross Status Reserved Bit Set	The transmitter has reported a status indication not understood by MC Toolkit.	Retry the operation, maybe some disturbance or noise caused unexpected byte on the communication line
Data Inaccessible	Unable to access the parameter value.	Same as Description
Bad character in Scratchpad	The scratchpad contains an invalid data byte.	Check the specification to identify the supported character set
Invalid Float value	Value is not a valid floating point value.	Some unacceptable character was entered
Value Out of Range	User-entered number is too high or too low.	Same as Description
Transmitter is in DE Mode. D/A Trim is allowed only in Analog Mode.	DE mode is digital only (no digital-to-analog conversion).	Same as Description
The transmitter is in Output Mode.	User tried to Exit MC Toolkit application	Same as Description

<b>MESSAGE</b>	<b>Description</b>	<b>Resolution / CORRECTIVE ACTION</b>
Are you sure you want to terminate the connection?	while the DE Transmitter is still in Output Mode.	
The changes you have made are about to be sent to the transmitter. Continue?	Values entered into this display will be written into transmitter memory.	Informational message
Please make sure you are connected to a DE device. Sending DE commands to a non-DE device could potentially cause a process upset.	DE communications (~ 4-20 mA amplitude) could cause erroneous transmission in non-DE protocols.	Same as Description
Leaving the Main Menu will require an upload in order to return. Are you sure you want to do this?	A new Upload will require approximately 60-second wait.	Same as Description
Put loop in Manual ... Trips secured?	Changing values of transmitter parameters can cause process upset.	Same as Description
Conformity must be square root to select this unit.	Units for Flow indications are available only when Square Root conformity is selected.	Same as Description
Are you sure you want to Reset All Corrects to factory defaults?	Executing Reset All Corrects will overwrite all user input calibration values (Zero, LRV, URV) with factory-default values.	Same as Description
Are you sure you want to place the transmitter in output mode (?)	In Output Mode, output current will be set to the selected constant value, rather than to calculated	Same as Description
Square Root is not allowed for GP and AP Sensor Types.	Square Root conformity is available only for FLOW (DP) input applications.	Same as Description

### Offline configuration Error Messages

MESSAGES	DESCRIPTION	Resolution / Corrective Action
All the options are saved!	Any changes made on the current dialog are saved	Informational message
Invalid file	Selected file name is not found in the Pocket PC	Informational message
You have selected the Template file and you cannot modify it. Do you want to save the Template file as the working copy?	MC Toolkit will be shipped with a template file with some default configurations. User cannot modify it. If you select this file for loading and editing parameters, you get this message. However you can save this Template file as the Working copy by providing a new file name. You can save any of this configuration file as the Template file by selecting the preferred configuration file and Saving it As "TEMPLMCT.XML". From this point on this will remain as the Template file	Same as description
The Template file has been successfully saved as the working copy!	When the Template file is selected and you accept the prompt to save the Template file as the Working copy you get this message on successful save of the file	Same as description
No items are selected!	On the Select Device Type dialog, if no items are selected in any of the 3 List boxes :Select Device Type, Select Revision, and Select Tag ID, you get this message on selecting "Edit Offline Params" button	Same as description
Memory Allocation Error!	If any of the Dynamic memory allocation fails you get this message	Try removing files that are not needed from the SD Card
Do you want to save your changes to the file?	If you made some changes to any of the parameters in any of the 3 Parameter dialogs and you select "<Back" button on the "Select Device Type" dialog without first selecting "Save to File" button, you get this message	Same as description
The Offline config. parameters are saved to the file!	The Offline config. parameters are saved from the program database to the file	Same as description
Could not save Offline config. parameters to the file!	Some error occurred during Save of the file and could not save the Offline config. parameters from the program database to the file	Try the operation again
Are you sure you want to download this configuration to the device?	On selecting "DOWNLOAD to Device" button on the "Select Device Type" dialog user gets this message to confirm his action in Offline Mode	Informational message
Are you sure you want to download this configuration to the current Online device?	On selecting "DOWNLOAD to Device" button on the "Select Device Type" dialog user gets this message to confirm his action in Online Mode	Informational message

Download failed!	<p>Could not download the selected configuration to the Device due to any of the following reasons:</p> <p>Device mismatch</p> <p>Version incompatibility</p> <p>Communication errors</p>	Try downloading to the right device
Version incompatibility found! Some of the parameters in version X of the device are not supported in version Y of the device. Download cannot proceed!	Download of configuration from the file with firmware version X could not be downloaded to the device with version Y of the device where $X > Y$ . This is because there are some parameters in version X that are not supported in version Y	Try downloading to the right device
Device mismatch found! Please make sure that you have connected to the right device...	The device type you trying to download the selected configuration does not match with the device type of the configuration in the file	Try downloading to the right device
Download completed successfully! Do you want to proceed to the MC TOOLKIT screen?	In Offline mode, after completion of the Download, you get this option to go back to MC TOOLKIT screen to do an Upload of the newly downloaded configuration	Informational message
Could not read Tag IDs from the file	On parsing the XML file, there was some error and could not read the Tag IDs from the file	Make sure the configuration file is not corrupted. Reinstall the MC Toolkit if the problem persists
Could not set Tag ID! Do you want to proceed with the rest of the download?	When the Write Tag ID command fails, you get this message. You can abort the rest of the download or continue	Same as the description
Could not set Line Filter! Do you want to proceed with the rest of the download?	When the Write Line Filter command fails, you get this message. you can abort the rest of the download or continue	Same as the description
Could not set one or all of the following parameters: Sensor type, Cold junction compensation, Break Detection, Linearity! Do you want to proceed with the rest of the download?	When the Write of any of the parameters in this list fails, you get this message. You can abort the rest of the download or continue	Same as the description
Could not download LRV / URV. The device will keep the values valid for its Sensor limits	When the Write of LRV / URV fails due to invalid range, you get this message indicating the device will set the values valid for the current sensor	Same as the description
Could not set Damping! Do you want to proceed with the rest of the download?	When the Write Damping command fails, you get this message. You can abort the rest of the download or continue	Same as the description
Could not set the Critical Status Latching configuration! Do you want to proceed with the rest of the download?	When the Critical Status Latching command fails, you get this message. You can abort the rest of the download or continue	Same as the description

## 6. Troubleshooting

### 6.3. MC Toolkit application software troubleshooting scenarios

Could not set one or all of the following parameters: Conformity, Damping! Do you want to proceed with the rest of the download?	When the Write Conformity and Damping command fails, you get this message. You can abort the rest of the download or continue	Same as the description
Could not set the Scratch Pad!	When the Write Scratch Pad command fails, you get this message.	Same as the description
No device selected! Download cannot proceed!	On the HART device list, you need to select the Device you want to Download the selected configuration. When no device is selected, and you select "Download to Device" button, you get this message	Same as the description
No device found! Download cannot proceed!	On polling the HART network, if no HART devices are found, you get this message	Same as the description
Could not read Delta value!	The Read Delta value command is sent every time you select the "SENSOR" button on the HART MAIN MENU screen before displaying the SENSOR screen. If the command fails you get this message	Same as the description
Could not save Online config. parameters to the file!	In Online mode, you can select "Save to File" to save the current online parameters to the file. If it fails, you get this message	Same as the description
The Online config. parameters are saved to the file!	Same as the message	Same as the description
No Device Types found! Please make sure that you have selected the right Config File	The file selected may be the wrong one. Also, if you are in DE mode and you select a file with no Configuration for the DE devices, then you get this message. Similarly, if you are in HART mode and you select a file with no configuration for the HART devices you get this message.	Same as the description
Lower Range Value is greater than the Upper Range Value!	You cannot set a LRV value greater than URV	Same as the description
The Template file name and the Working file name cannot be the same, please provide a different name...	You can save the Template file as his working copy. But the working file name cannot be the same as the Template file name	Same as the description
File name already exists. Do you want to overwrite the existing file?	You can save the Template file as his working copy. If the working file name already exists, then you get this message	Same as the description
File name cannot be blank! Please provide a file name...	You can save the Template file as his working copy. You need to provide a file name for the working copy	Same as the description Same as the description
The system resources are running low. Please close the MC Toolkit program by selecting File/Exit menu!	When a program is stale for a long time without any user inputs, the Pocket PC enters into Hibernation mode. When it enters this mode and the program captures the windows message you may see this message and it is recommended that the program be closed.	
Closing the MC Toolkit program	When you select the File / Exit menu you get this message	Informational Message

### 6.3. MC Toolkit application software troubleshooting scenarios

---

<p>The current config. file ....XML has reached its limit of 200 Tag IDs / Records, please save the configuration to a new file</p>	<p>The requirement was to support at least 100 Tag IDs. But the program allows to Save MAX 200 configurations / Tag IDs in the same file. Once it reaches this limit, you get this message if you try to save a new configuration to the same file However you should be able to update any of the 200 configurations without changing the Tag ID.</p>	<p>Same as the description</p>
<p>Are you sure you want to leave the Device List screen?</p>	<p>You get this message when you select Back button on the HART Device List screen. This screen lists all the devices on the HART network. If you select to go back to the previous screen without doing download, the program needs to poll the network again to list the devices</p>	<p>Same as the description</p>
<p>Are you sure you want to cancel the download?</p>	<p>You get this message when you select Back button with a selected device from the list, on the HART Device List screen. This screen lists all the devices on the HART network. If you select to go back to the previous screen without doing download, the program needs to poll the network again to list the devices</p>	<p>Same as the description</p>

## 7. MC Toolkit Maintenance

### 7.1 MCT404 battery replacement

#### Battery Status


Refer to “About the Battery” section of the “*300011CB02A01\_instruction\_manual\_irocCi70-Ex\_EN.pdf*” that is shipped with the MCT404 product

#### Battery Replacement

The battery is replaceable in the field.

The MCT404 uses following rechargeable Lithium-ion battery pack as the main power source:

- 3.7 V, 4000 mAh (14.8 Wh) battery AM Ci70 –Ex

	<b>WARNING!!</b>
	The battery used in this device may present a fire or chemical burn hazard if it is mistreated. Do not disassemble it, heat it above 60 °C (140 °F) or incinerate it. Dispose of used batteries promptly. Keep away from children.

#### Charge the Battery

You need to fully charge the battery before using your MCT404 for the first time.

**Battery care:** Refer the “About Battery Life and Conservation” section of the “*300011CB02A01\_instruction\_manual\_irocCi70-Ex\_EN.pdf*” that is shipped with the MCT404 product

#### Replace the Battery

If your battery power is low, you need to either charge the battery in the MCT404, or replace it with a charged battery.

1. Save your files and close any open applications.
2. Press the Power button and choose Shutdown from the menu to shut down the MCT404.
3. Detach the handstrap from the MCT404. See Figure 7-1
4. Make sure the MCT404 is in hibernate mode and that the screen has turned off.
5. Remove the battery. Unscrew the battery’s screw using enclosed screwdriver. Lift lower part of the battery to release it from the MCT404. See Figure 7-2
6. Insert the top end of a fully charged battery into the MCT404, and press down firmly on the bottom of the battery. Then tighten the screw. Make sure that the battery is firmly attached.

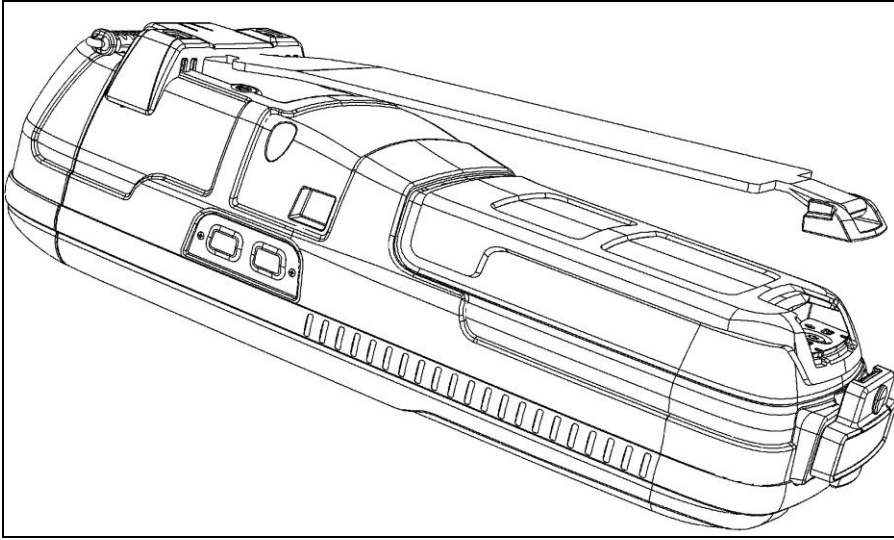


Figure 7-1 Remove Handstrap

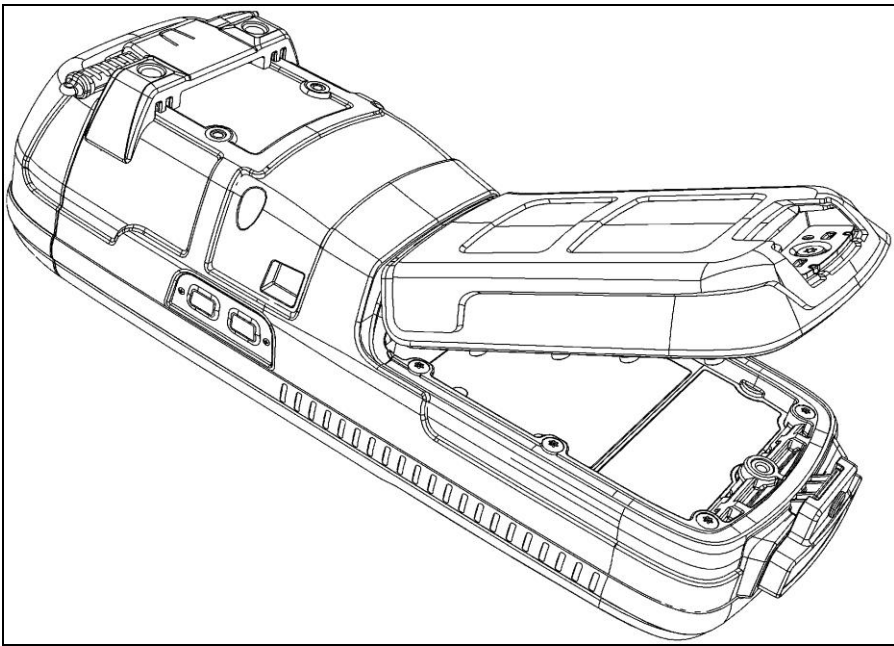


Figure 7-2 Remove Battery Cover

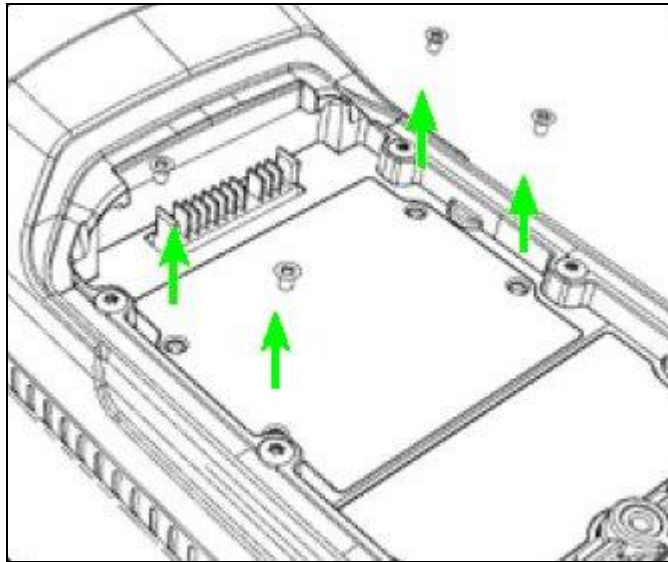


## 7.2 SD card replacement

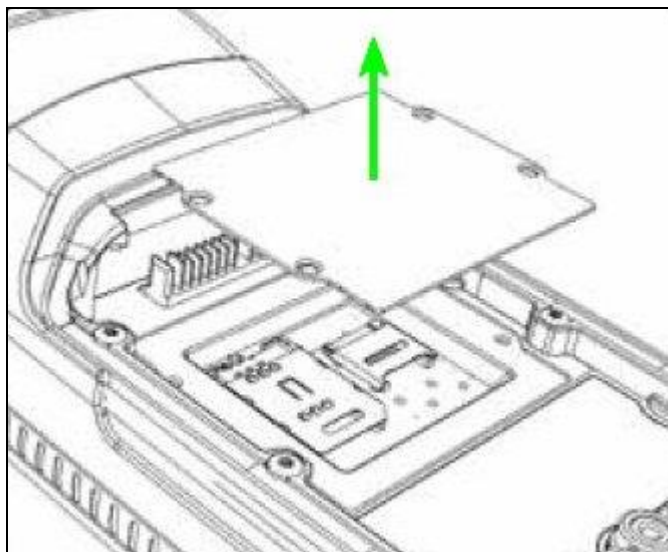
### MCT404 SD Card Replacement

Use an SD card to increase file storage and install software. The MCT404 supports an optional 32 GB maximum capacity SD card.

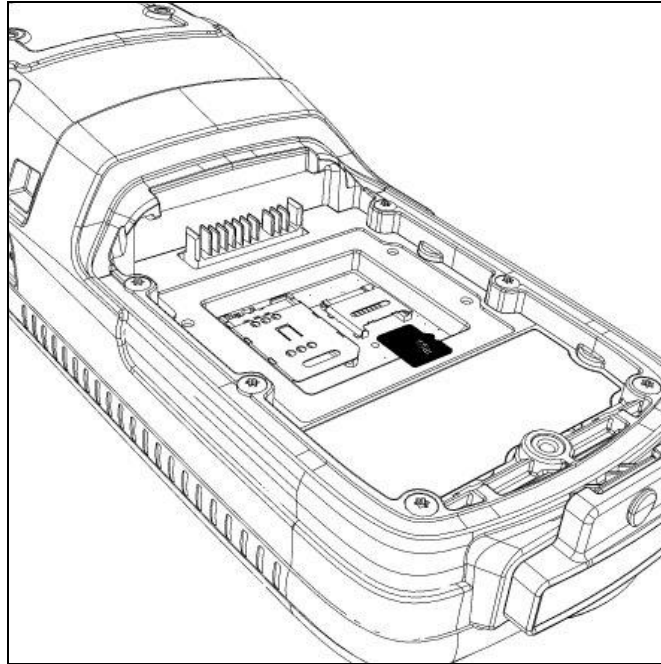
1. Press the Power button to turn off the MCT404.
2. Remove the handstrap and the battery. See Figure 7-1
3. Remove the four Phillips screws and open the card access door.



4. Slide the SIM card door to the left to unlock it and open the door.
5. Slide the SD card door towards the top of the computer to unlock it and open the door.



6. Remove any existing SD card,
7. Slide the new SD card into place.



**Figure 7-3 SD Card Replacement**

1. Close the SD card door and slide it towards the bottom of the MCT404 to lock it in place.
2. Close the SIM card door and slide it to the right to lock it in place.
3. Close the card access door. Then replace the cover plate and fasten the four screws.
4. Install the battery. Press down firmly on the bottom of the battery. Then tighten the screw.
5. Reattach the handstrap.
6. Press the Power button. The MCT404 cold boots.

**Note:** The MCT404 resets when you open the card access door to insert the SD card. Make sure you completely close the card access door before you use your MCT404.

## 8. Appendix A: Application Notes

### 8.1 Application Notes

#### Synchronization between PDA and PC

##### *Windows XP: ActiveSync/Mobile Device Center connection*

Connect the ActiveSync/Mobile Device Center cable from the PDA base to a USB port on the PC.

ActiveSync/Mobile Device Center should start automatically. If your PDA is synced with the PC, you see the Screen Y. If the screen does not come up maximized, you will see the icon on your Desktop Taskbar. Double tap on the icon to maximize.

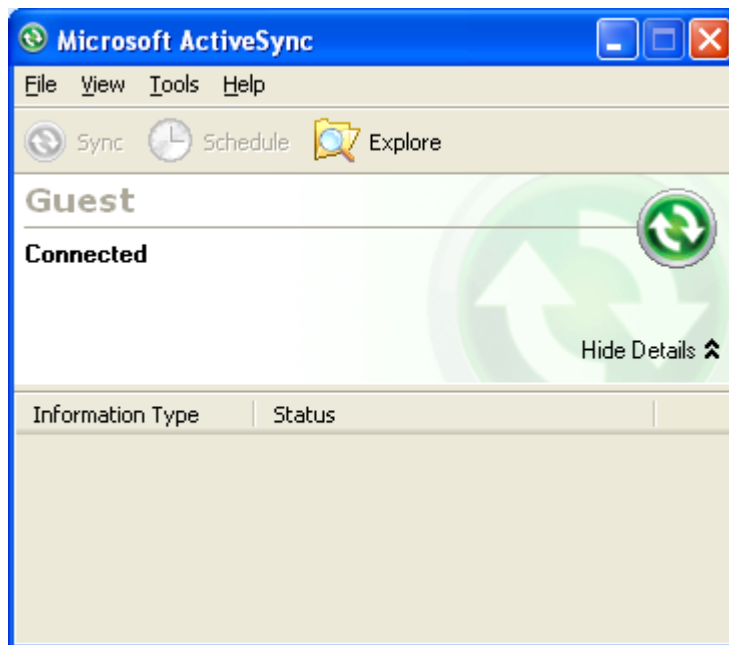
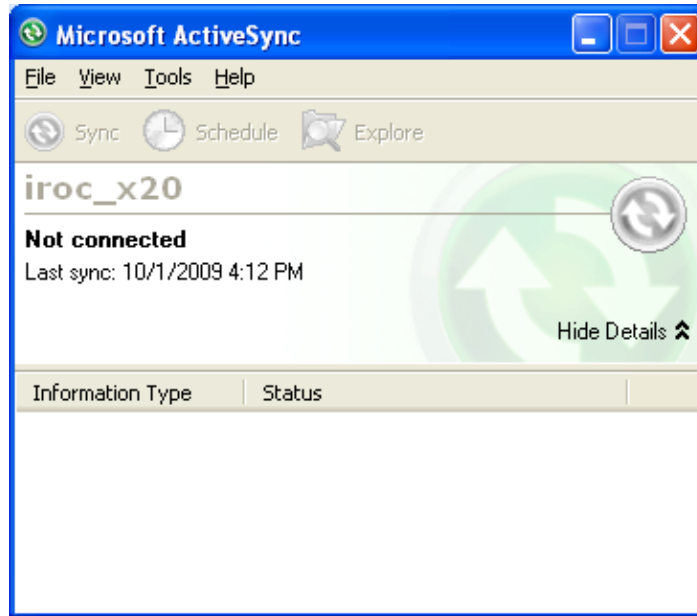
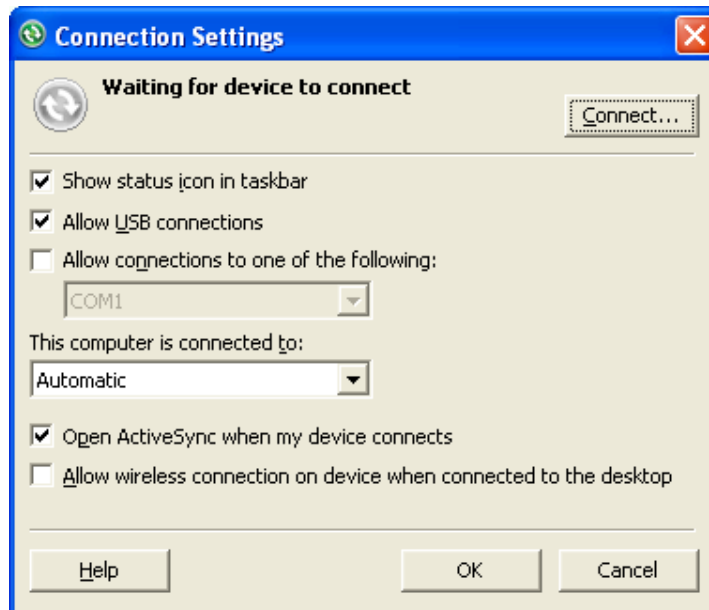


Figure 8-1 Screen Y

If you do not see the **Screen Y**, select Start\All Programs\Microsoft ActiveSync\Mobile Device Center. It is likely that your PDA is not synched up with your PC and you will see the screen below.



Select **File/Connection Settings** and set the Connection settings as below. Select OK.



The Sync process should start now. If you are still not connected, then **Soft Reset the PDA** with the Sync cable still connected between the PDA base and the PC.

This should automatically establish synch connection between the PDA and the PC and you should see the **Screen Y**

### **Windows Vista and Windows 7: Mobile Device Center connection**

Connect the ActiveSync/Mobile Device Center cable from the PDA base to a USB port on the PC.

Windows Mobile Device Center should start automatically. If your PDA is synched with the PC, you see the screen below. If the screen does not come up maximized, you will see the icon on your Desktop Taskbar. Tap on the icon to maximize.



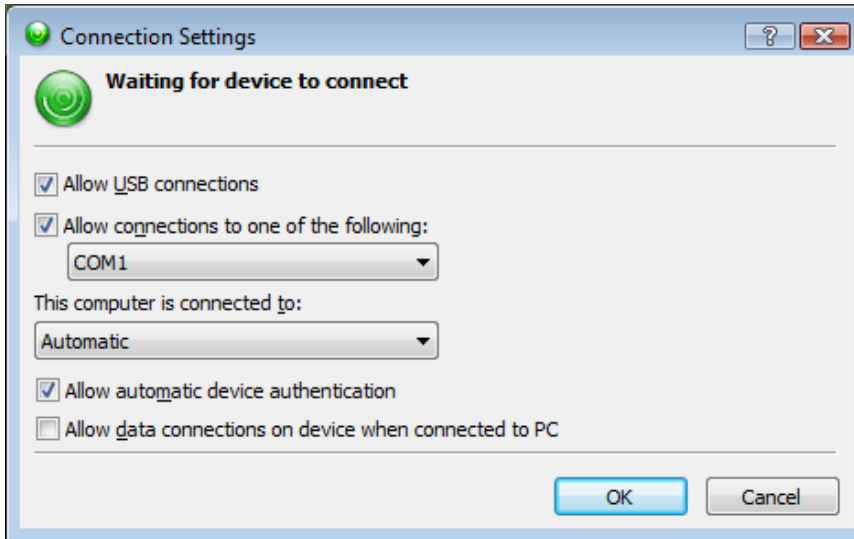
**Figure 8-2 Screen X**

You can proceed with the MC Toolkit Installation following the Instructions on the 34-ST-33-58

If you do not see the **Screen X**, select Start\All Programs\Windows Mobile Device Center. It is likely that your PDA is not synched up with your PC and you will see the screen below.



Select **Mobile Device Settings** and set the Connection settings as below. Select **OK**.

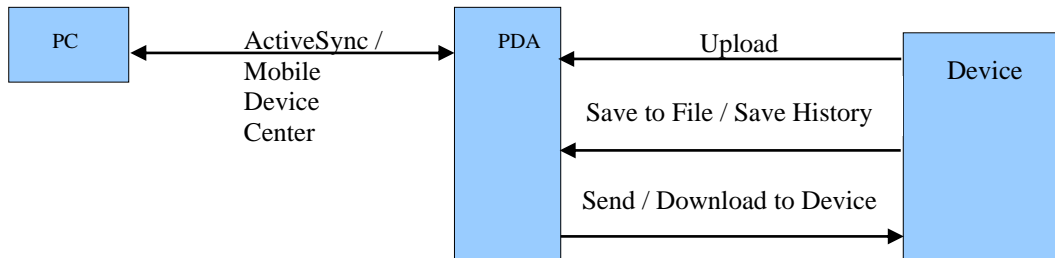


The Synchronise process should start now. If you are still not connected, then **Soft Reset the PDA** with the Sync cable still connected between the PDA base and the PC.

This should automatically establish synchronise connection between the PDA and the PC and you should see the **Screen X**

## File Transfer

File Transfer between Pocket PC and PC is achieved by the ActiveSync/Mobile Device Center interface.



**Figure 8-3 ActiveSync/Mobile Device Center file transfer**

### **ActiveSync/Mobile Device Center**

Establishes connection between PC and PDA.

Allows you to copy files between PC and PPC once the connection is established.

Allows the MC Toolkit Installation program to install the Application related files

### **Upload**

Allows Upload of Config parameters from the Device to the PDA in Online mode

### **Save to File**

Allows saving current Online configuration to an XML file within the PDA. Also allows editing and saving the Offline Configuration parameters back to the file – applicable to DE devices using MC Toolkit application

### **Save History**

Allows saving current Online configuration as a History file within the PDA – applicable to Universal HART devices using FDC application

### **Send**

Allows writing changes to one or multiple parameters in the Device in Online Mode

### **Download to Device**

In MC Toolkit application, this allows selection of an XML configuration file within the PDA in Offline mode, load the parameters, Edit and send to the device after establishing connection. In FDC application, this allows selection of a FDM configuration file within the PDA in Offline Mode, Load and View the parameters, select the parameters to be sent to the device after establishing connection.

## Using Infrared Red Port for OneWireless Devices

This section describes how the Infrared Red Port can be used to securely transmit Authenticating Keys for OneWireless devices installed in the field.

The MCT404 model authenticates ISA100 wireless devices and supports Honeywell's PIE tool to manage UDA2182 analyzers and UDC Controllers.

### *Using the IrDA Port*

Using the IrDA port, you can send and receive data between the terminal and other devices equipped with infrared. This can include, but is not limited to, Windows Mobile information such as Contacts and Tasks, as well as software upgrades.

### *IrDA Port Location*



IrDA Port

**Figure 8-4 MCT404 Infrared port location**

### *Provisioning*

Before the transmitter can be configured it must be unlocked with a security key so it can join the network. Use the Provisioning Device Pocket PC software to receive security keys from the Key Server manager, then aim the Pocket PC at the transmitter and transmit a key.

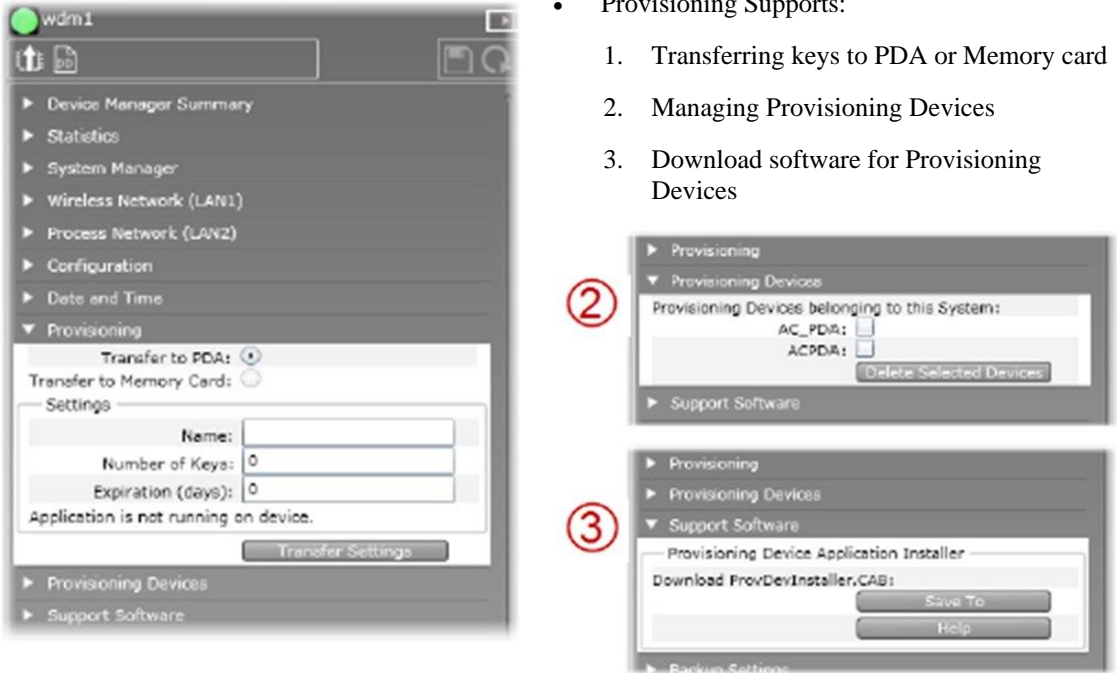
### **Provisioning Device**

The provisioning device is used to provide security credentials to FDAPs and Field Devices (FD) so that they may join the ISA100 network.

FDAPs and FDs require security credentials that the WDM verifies before they are allowed to join the ISA100 network.

The provisioning device is used to provide the FDAPs and FDs with these security credentials via an IR port.





The image contains three screenshots of the WDM1 application interface, each marked with a circled number:

- 1**: A screenshot of the main application window. The 'Provisioning' menu item is expanded, showing options for 'Transfer to PDA' (selected), 'Transfer to Memory Card', and 'Settings'. The 'Settings' section includes fields for 'Name', 'Number of Keys' (set to 0), and 'Expiration (days)' (set to 0). A status message reads 'Application is not running on device.' and a 'Transfer Settings' button is visible.
- 2**: A screenshot of the 'Provisioning Devices' sub-menu. It displays a list of 'Provisioning Devices belonging to this System:' with checkboxes for 'AC\_PDA' and 'ACPDA'. A 'Delete Selected Devices' button is located below the list.
- 3**: A screenshot of the 'Support Software' sub-menu. It features a section titled 'Provisioning Device Application Installer' with a 'Download ProvDevInstaller.CAB:' button. Below this are 'Save To' and 'Help' buttons.

- Provisioning Supports:
  1. Transferring keys to PDA or Memory card
  2. Managing Provisioning Devices
  3. Download software for Provisioning Devices

Over-the-air provisioning allows a user to accept or reject an un-provisioned ISA100 Wireless field device via WDM’s user interface. With this method, an external provisioning device (PDA) would no longer be necessary.

### Configuring the Provisioning Device

#### Prerequisite

- ActiveSync should be installed on the clients PC connected to WDM
  - Active Sync software is usually shipped on a CD along with the Provisioning Device
  - Active Sync software can be downloaded from Microsoft
- Provisioning Device should have .NET Compact Framework Installed
  - .NET Compact Framework can be downloaded from Microsoft
  - Run .msi on PC, it will install framework on PDA
- Provisioning Device should be connected to the client PC
  - Can browse files through the PC using ActiceSync
- Check if “Dot net CF 3.5” software is installed on your PC
  - From your PDA click on Start > Settings
  - Select system Tab
  - Click on Remove Programs
  - Check if the list has “Microsoft .net CF 3.5”

### Installing Provisioning Device Software

- Log on to the WDM, select WDM in Monitoring, go to its properties
  - Expand “Support Software”
  - In the “Save To” dialog box, save the cab file to PC (eg. “ProvDevInstaller.cab”, “PDA.cab”)
  - Copy from WDM to PC, then copy cab from PC to PDA
  - Click cab file to install the cab file on the PDA

### Writing Provisioning Information

- Provisioning Device Name – Unique name, up to 32 characters long
- Number of keys - Maximum number of keys is 100
- Expiration – maximum number of days that the keys may be valid is 31

### Sending Provisioning Information

- Select WDM in selection panel, expand “Provisioning”
- Enter name, Number of Keys, Expiration
- Connect the Provisioning Device to the WDM via one of its USB ports
- Click “Transfer Settings” button.

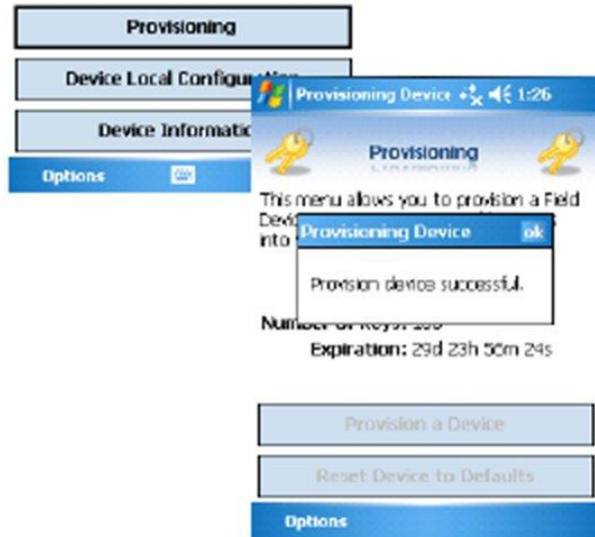


## Provisioning Devices

- Field device Access Points (FDAP) and Field Devices (FD) are provisioned before they can join ISA100 network
- How to provision PFDAP/FD:
  - Launch the Provisioning software in the PD
  - Click “Provisioning”
  - Point the IR port of the PD at the IR port on the FDAP/FD to be Provisioned
  - Click on the “Provision a Device” button on the PD
  - Security credentials will be transferred to the FDAP/FD through the IPR port
  - PD’s display a message indicating whether provisioning was successful



The Provisioning Device application is used to provision Field Device Access Points and Field Devices into your OnaWireless network. Please select an option below.



## TX Power Setting

Transmitters shipped from the factory will have its Transmitter Power (TX) value set according to its Model Number and this value is consistent with those values given in Table 7-4.

The TX Power setting may be changed via the Authentication Device when a special application (app) is installed. This app is considered to be Honeywell sensitive material and is made available only to the qualified Professional Installer.

Due to radio approval body regulations, changing the TX Power setting is only available if the professional installer option has been explicitly enabled on your Authentication Device.



### **WARNING:**

The Transmitter must be Professionally Installed in accordance with the requirements specified in this document. Only the specified power settings, antenna types and gains and cable lengths (attenuation) as outlined in this document are valid for Transmitter installations.

## Maintenance

The IR Port will show LRV, URV and other configuration information.

## **9. Appendix B:**

### **9.1 MCT Power Save Guidelines**

When not in use, always turn off the PDA.

Do not leave the MC Toolkit or FDC applications running if not in use; exit the applications to save modem battery.

## 10. Appendix C: Replacement Parts

### 10.1 MCT404 Accessories & Spare Parts

Table 18 MCT404 Replacement Parts

<b>Accessories/Spare Parts</b>	<b>Part Number</b>
CD-ROM (FDC 2.X software + MC Toolkit software)	51453286-501
Power supply for docking station	50079567-002
Power Cord(US)	50079567-003
Power Cord (EU)	50079567-004
Power Cord (UK)	50079567-005
Power Cord (AU)	50079567-006
Docking station, Power Supply and USB cable for computer interface	50079567-007
Stylus for the MCT404 Touch screen	50079567-008
Transmitter connector cable (with one set of Alligator Clips and one set of EZ Clips)	50079567-009
Spare Battery	50079567-010
Leather carrying case (Stylus/shoulder strap included)	50079567-011
Hand strap	50079567-012

## Sales and Service

For application assistance, current specifications, pricing, or name of the nearest Authorized Distributor, contact one of the offices below.

### ASIA PACIFIC

Honeywell Process Solutions,  
(TAC) [hfs-tac-support@honeywell.com](mailto:hfs-tac-support@honeywell.com)

#### Australia

Honeywell Limited  
Phone: +(61) 7-3846 1255  
FAX: +(61) 7-3840 6481  
Toll Free 1300-36-39-36  
Toll Free Fax:  
1300-36-04-70

#### China – PRC - Shanghai

Honeywell China Inc.  
Phone: (86-21) 5257-4568  
Fax: (86-21) 6237-2826

#### Singapore

Honeywell Pte Ltd.  
Phone: +(65) 6580 3278  
Fax: +(65) 6445-3033

#### South Korea

Honeywell Korea Co Ltd  
Phone: +(822) 799 6114  
Fax: +(822) 792 9015

### EMEA

Honeywell Process Solutions,  
Phone: + 80012026455 or  
+44 (0)1344 656000

Email: (Sales)

[FP-Sales-Apps@Honeywell.com](mailto:FP-Sales-Apps@Honeywell.com)

or

(TAC)

[hfs-tac-support@honeywell.com](mailto:hfs-tac-support@honeywell.com)

### AMERICA'S

Honeywell Process Solutions,  
Phone: (TAC) 1-800-423-9883 or  
215/641-3610  
(Sales) 1-800-343-0228

Email: (Sales)

[FP-Sales-Apps@Honeywell.com](mailto:FP-Sales-Apps@Honeywell.com)

or

(TAC)

[hfs-tac-support@honeywell.com](mailto:hfs-tac-support@honeywell.com)

*Specifications are subject to change without notice.*

### For more information

To learn more about MCToolkit,  
visit [www.honeywellprocess.com](http://www.honeywellprocess.com)  
Or contact your Honeywell Account Manager

### Process Solutions

Honeywell  
1250 W Sam Houston Pkwy S  
Houston, TX 77042

Honeywell Control Systems Ltd  
Honeywell House, Skimped Hill Lane  
Bracknell, England, RG12 1EB

Shanghai City Centre, 100 Jungi Road  
Shanghai, China 20061

[www.honeywellprocess.com](http://www.honeywellprocess.com)

# Honeywell

34-ST-25-50 Rev.4

July 2017

©2017 Honeywell International Inc.